



Kawasaki

Motorcycle
Motocyclette
Motorrad

保存版

**Owner's Manual
Manuel du Propriétaire
Betriebsanleitung**

KLX650R



A stylized graphic of a staircase with black steps and white risers, ascending from the bottom left to the top right. The steps are rectangular and arranged in a perspective view.

ENGLISH

Motorcycle Owner's Manual



Whenever you see the symbols shown below, heed their instructions! Always follow safe operating and maintenance practices.

WARNING

This warning symbol identifies special instructions or procedures which, if not correctly followed, could result in personal injury, or loss of life.

CAUTION

This caution symbol identifies special instructions or procedures which, if not strictly observed, could result in damage to or destruction of equipment.

NOTE

○ This note symbol indicates points of particular interest for more efficient and convenient operation.

IMPORTANT

Off-road motorcycle riding is a wonderful sport, and we hope you will enjoy it to the fullest.

However, if improperly conducted, the sport has the potential to cause environmental problems as well as conflicts with other people. Responsible use of your off-road motorcycle will ensure that these problems and conflicts do not occur.

TO PROTECT THE FUTURE OF YOUR SPORT, MAKE SURE YOU USE YOUR BIKE LEGALLY, SHOW CONCERN

FOR THE ENVIRONMENT, AND RESPECT THE RIGHTS OF OTHER PEOPLE.

WARNING

- **THIS VEHICLE IS AN OFF-ROAD VEHICLE ONLY AND WAS NOT MANUFACTURED FOR USE ON PUBLIC STREETS, ROADS, OR HIGH-WAYS.**
- **USE YOUR BIKE LEGALLY.**
- **RESPECT THE ENVIRONMENT AND THE RIGHTS OF OTHER PEOPLE.**

TAMPERING WITH NOISE CONTROL SYSTEM PROHIBITED:

Federal law prohibits the following acts or the causing thereof: (1) the removal or rendering inoperative by any person other than for purposes of maintenance, repair, or replacement, of any device or element of design incorporated into any new vehicle for the purpose of noise control prior to its sale or delivery to the ultimate purchaser or while it is in use, or (2) the use of the vehicle after such device or element of design has been removed or rendered inoperative by any person.

Among those acts presumed to constitute tampering are the acts listed below:

- Replacement of the original exhaust system or muffler with a component not in compliance with Federal regulations.
- Removal of the muffler(s) or any internal portion of the muffler(s).
- Removal of the air box or air box cover.
- Modifications to the muffler(s) or air intake system by cutting, drilling, or other means if such modifications result in increased noise level.

Foreword

We wish to thank you for choosing this fine Kawasaki Motorcycle. It is the end product of Kawasaki's advanced engineering, exhaustive testing, and continuous striving for superior reliability, safety, and performance. By giving your motorcycle the proper care and maintenance outlined in this manual, you will be helping to ensure it a long, trouble-free life.

Before starting to ride your motorcycle, please read this manual thoroughly in order to know your motorcycle's capabilities, its limitations, and above all, how to operate it safely.

Due to improvements in design and performance during production, in some cases there may be minor discrepancies between the actual vehicle and the illustrations and text in this manual.

Primary reduction ratio	5th	0.791 (19/24)
Final reduction ratio		2.272 (75/33)
Overall drive ratio		3.500 (49/14)
		6.297 (Top gear)
Frame		
Type		Tubular, semi-double cradle
Steering angle		41° to either side
Castor		28.5°
Trail		122 mm (4.80 in)
Tire size:	Front	80/100-21 51M, DUNLOP D752F
	Rear	110/100-18 64M, DUNLOP D752
Suspension:	Front	Telescopic fork (upside-down)
	Rear	Swingarm (Uni-trak)
Front Suspension stroke		300 mm (11.81 in)
Rear Wheel travel		272 mm (10.71 in.)
Front fork oil (each)		KAYABA 01 or SAE 5W, 544-560 mL (18.39 – 18.93 US oz)
Front fork oil level (compressed, spring removed)		90 mm (3.54 in)
Brakes		
Type:	Front and Rear	Disc brake
Effective disc diameter:	Front	224 mm (8.82 in)
	Rear	195 mm (7.68 in)
Electrical Equipment		
Headlight		12 V 30 W (quartz-halogen)
Taillight		2 V 10 W

Specifications subject to change without notice, and may not apply to every country.

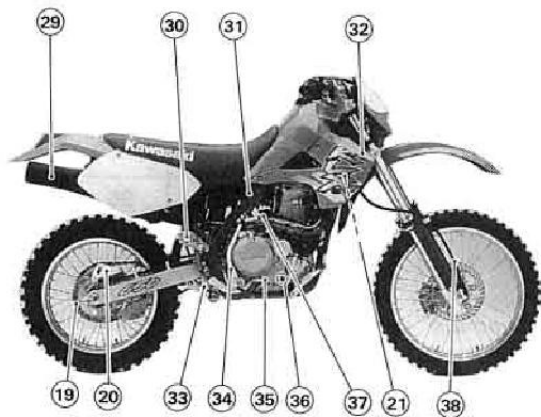

- 29. Spark Arrester
- 30. Rear Brake Reservoir
- 31. Carburetor
- 32. Radiator Cap
- 33. Uni-trak Tie Rod and
Rocker Arm
- 34. Kick Pedal
- 35. Rear Brake Pedal
- 36. Oil Level Gauge
- 37. Idle Adjusting Screw
- 38. Meter Cable

Fuel

The Kawasaki KLX has a 4-stroke engine that requires a gasoline.

The capacity of the fuel tank is 11.6 L (3.06 US gal). To open the fuel tank cap, pull out the breather hose from the clamp on the handlebar, and turn the tank cap counterclockwise.

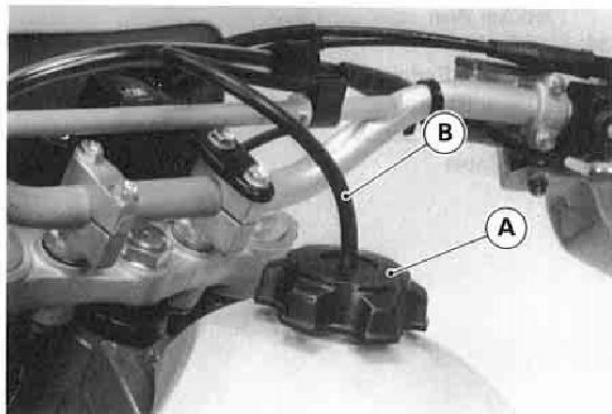

A. Fuel Tank Cap

B. Breather Hose

Recommended Fuel

Use premium gasoline with an octane rating equal to or higher than that shown in the table.

Octane Rating Method	Minimum Rating
Antiknock Index $\frac{(\text{RON} + \text{MON})}{2}$	90 or more
Research Octane Number (RON)	95 or more

NOTE

○ If "knocking" or "pinging" occurs, try a different brand of gasoline or higher octane grade.

⚠ WARNING

Gasoline is extremely flammable and can be explosive under certain conditions. Always stop the engine and do not smoke. Make sure the area is well ventilated and free from any source of flame or sparks; this includes any appliance with a pilot light.

Fuel Tap

The fuel tap has three positions: OFF, ON, and RES (reserve). If the fuel runs out with the tap in the ON position, the last 0.8 L (0.21 US gal) of fuel can be used by turning the tap to RES.

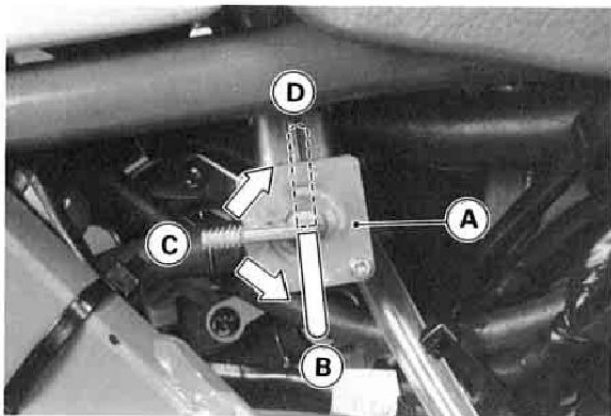

A. Fuel Tap

B. ON position

C. OFF position

D. RES position

NOTE

- Since riding distance is limited when on RES, refuel at the earliest opportunity.
- Make certain that the fuel tap is turned to ON (Not RES), after filling up the fuel tank.

⚠ WARNING

Practice operating the fuel tap with the motorcycle stopped. To prevent an accident you should be able to operate the fuel tap while riding without taking your eyes off the road.

Be careful not to touch the hot engine while operating the fuel tap.

Meter Unit

In the meter face is the trip meter. The trip meter shows the distance traveled since it was last reset to zero. The trip meter can be reset to zero by pulling out the reset knob and turn it to either side.

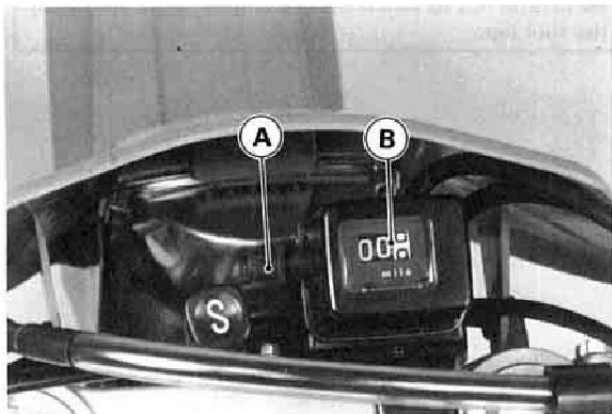

A. Reset Knob

B. Trip Meter

Engine Stop Button

The engine stop button is located on the left side of the handlebar. For ordinary engine stoppage and, if some emergency requires stopping the engine, press the button until the engine stops.

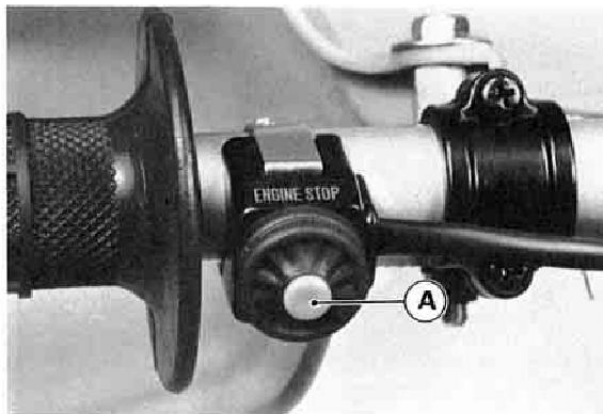

A. Engine Stop Button

Light Switch

The light switch is located on the right side of the handlebar. The switch positions are identified on the switch housing.

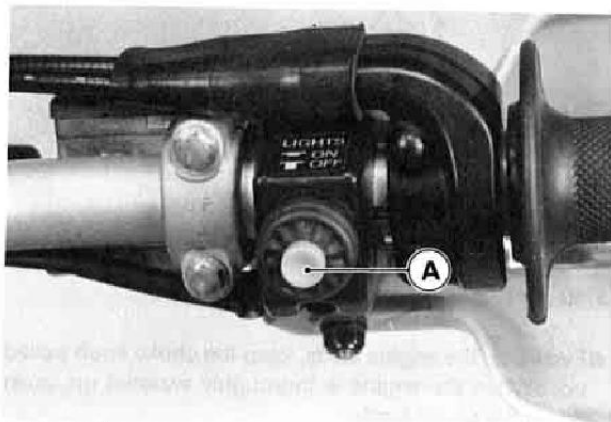

A. Light Switch

Starting the Engine

● Turn the fuel tap to the ON position.

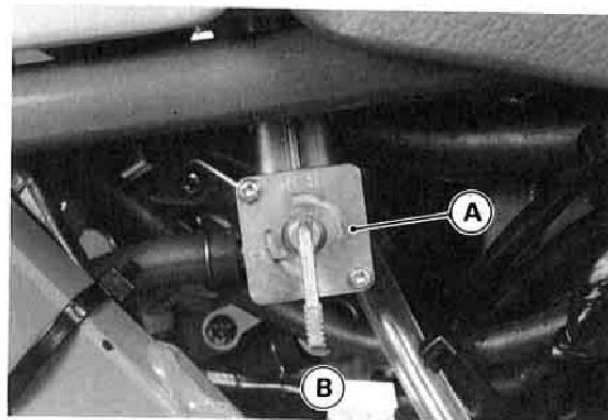

A. Fuel Tap

B. ON position

● If the engine is cold, pull up the choke knob.

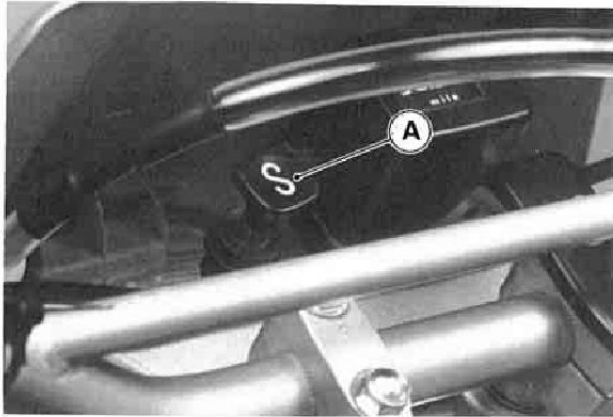

A. Choke Knob

- Make certain the transmission is in neutral.
- Kick the engine over, leaving the throttle closed.



A. Kick Pedal

- Even after the engine starts, keep the choke knob pulled up. When the engine is thoroughly warmed up, push down the choke knob.

NOTE

- *When the engine is already warm or on hot day, open the throttle part way instead of using the choke knob.*
- *If the engine is flooded, kick with the throttle fully open until the engine starts.*
- *If the clutch lever is pulled, the motorcycle can be started while in any gear.*

Shifting Gears

The transmission is a 5-speed, return shift type with neutral halfway between 1st and 2nd gears. A "return shift" means that to go back to first gear from a higher gear, you must shift back through the gears one by one. The same is true when upshifting: each gear must be engaged before the next higher gear may be selected.

To engage first gear from neutral, pull in the clutch lever and push down on the shift pedal, gently release the clutch lever, then release the shift pedal.

To shift to the next higher gear; pull in the clutch lever, lift the shift pedal with your toe, gently release the clutch lever, and then release the shift pedal.

To shift to the next lower gear; disengage the clutch, push the shift pedal down as far as it will go, engage the clutch gently, and then release the shift pedal.

CAUTION

When changing gears, press firmly on the shift pedal to ensure complete, positive shifting. Careless, incomplete shifts can cause the transmission to jump out of gear and lead to engine damage.

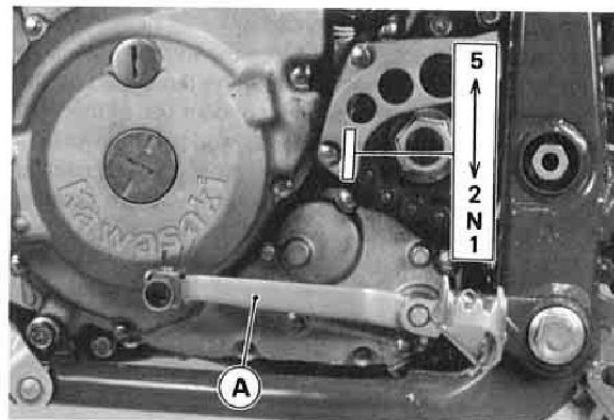

A. Shift Pedal

Stopping the Motorcycle

For maximum deceleration, close the throttle and apply both front and rear brakes. Disengage the clutch as the motorcycle comes to a stop. Independent use of the front or rear brake may be advantageous under certain conditions. Downshift progressively as speed is reduced to ensure good engine response when you want to accelerate.

Stopping the Engine

- Shift the transmission into neutral.
- After racing the engine slightly, close the throttle completely and push the engine stop button.

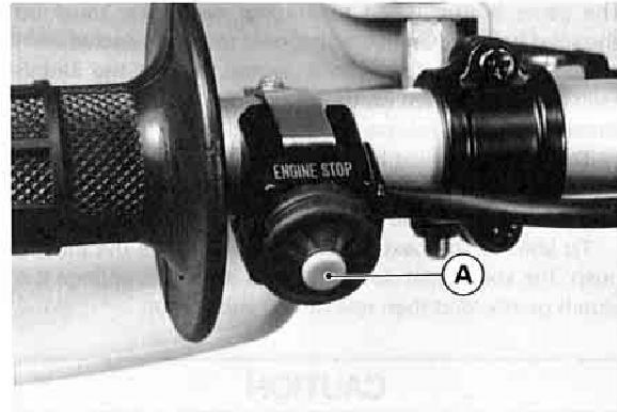

A. Engine Stop Button

- Turn the fuel tap to the OFF position.

Break-In

To obtain the proper operating clearance in the engine and transmission that are necessary for smooth engine performance and reliability, a brief break-in procedure must be carried out. For the first hour or 20 km (12 mi) of operation, run the engine at low and moderate r/min (rpm).

Break-in according to the following steps.

1. Start the engine and let it run at idle until the engine is thoroughly warmed up.
2. Stop and let the engine cool completely.
3. Start the engine and ride for 10 minutes at moderate speed – **NEVER HARD ACCELERATION.**
4. Stop and let the engine cool completely. Be sure to check and adjust chain slack and spoke tightness and make a general inspection.
5. Start the engine and ride for 20 minutes at moderate speed – **NEVER HARD ACCELERATION.**
6. Stop and let the engine cool completely. Check and adjust as step 4.
7. Start the engine and ride for 30 minutes at moderate speed – **NEVER HARD ACCELERATION.**
8. Stop and let the engine cool completely. Check and adjust as in step 4.
9. After the break-in procedure has been properly carried out, the motorcycle is ready for regular operation. However, since recklessly high r/min (rpm) will lead to engine trouble, take care to use the necessary skill and technique in operating the motorcycle.

Daily Pre-ride Inspection

Check the following items each day before you ride. The time required is minimal, and habitual performance of these checks will help ensure you a safe, reliable ride.

If any irregularities are found during these checks, refer to the appropriate owner's manual section and take the action required to return the motorcycle to a safe operating condition.

▲ WARNING

Failure to perform these checks every day before you ride may result in serious damage or severe accident.

Engine

Engine oil	Engine oil level correct.
Coolant.....	No coolant leakage, coolant level between level lines (when engine is cold).
Radiator cap	Properly installed.
Spark plug	Tighten to correct torque.
Clutch	Clutch functioning properly.
Carburetor	Adjusted properly.
Air cleaner	Clean, properly installed.
Muffler.....	Muffler not damaged.
Engine sprocket.....	Not worn or damaged.

Frame

Tires	Check overall condition; wear, cuts and other damage. Check pressure.
Spokes.....	Check for any loose spokes.
Drive chain	Check overall condition and chain slack, oil as necessary.
Brakes; front and rear.....	Function properly, brake lever and pedal have correct play. No brake fluid leakage.
Throttle	Functions properly, returns smoothly.
Steering	Action is smooth but not loose from lock to lock. No binding of control cables.
Front fork.....	Functions properly, no oil leakage.
Rear shock absorber	Function properly, no oil leakage.
Fuel tank.....	Mounted securely, no fuel leakage.
Rear sprocket	Not worn or damaged.
Electrical equipment.....	Functions properly.
Engine stop button	Functions properly.
Nuts, bolts, fasteners.....	Tighten any loose bolts and nuts.

After-Race Check Points

After racing, first clean the motorcycle (Pg. 65), then inspect the entire motorcycle with special attention to the air cleaner, carburetor, brakes, etc.

Carry out general lubrication (Pg. 66) and make adjustments as necessary.

FREQUENCY OPERATION		Traveled Distance km (mi)					See Page
		100 (60)	500 (300)	1000 (600)	1500 (900)	2000 (1200)	
CHASSIS	* Brake fluid-change	Every 2 years					—
	* Master cylinder cup and dust seal-replace	Every 2 years					—
	* Caliper piston seal and dust seal-replace	Every 2 years					—
	* Brake and fuel hose-replace	Every 4 years					—
	Spoke tightness and rim runout-check †	●	●	●	●	●	57
	Drive chain-adjust	Every 300 km (200 mi)					35
	Drive chain-lubricate	Before and after each day of operation					39,69
	Drive chain wear-check †	●	●	●	●	●	37
	Chain guide and slipper-check †	Damaged					38
	Front fork-inspect/clean	●	●	●	●	●	46
	* Front fork oil-change	Every year					—
	Nuts, bolts, fasteners-check †	●		●		●	61
	Fuel system-clean	●	●	●	●	●	—
	Steering play-check †	●	●	●	●	●	44
	* Steering stem bearing-grease					●	—
	Rear sprocket-check †		●	●	●	●	39
	General lubrication-perform	●	●	●	●	●	66
	* Wheel bearing-check †					●	—
Swingarm and Uni-Trak linkage pivots-grease		●	●	●	●	—	
* Swingarm and Uni-Trak linkage pivots-check †		●	●	●	●	—	
* Rear shock oil-replace	Every year					—	

† Replace, add, adjust or torque if necessary.

* Should be serviced by referring to the Service Manual or an authorized Kawasaki dealer.

Engine Oil

In order for the engine, transmission, and clutch to function properly, maintain the engine oil at the proper level, and change the oil and oil filter periodically. Not only do dirt and metal particles collect in the oil, but the oil itself loses its lubricative quality if used too long.

⚠ WARNING

Motorcycle operation with insufficient, deteriorated, or contaminated engine oil will cause accelerated wear and may result in engine or transmission seizure, accident, and injury

Oil Level

- Situate the motorcycle so that it is perpendicular to the ground.
- If the oil has just been changed, start the engine and run it for several minutes at idle speed. This fills the oil filter with oil. Stop the engine and leave it for one minute.

CAUTION

Racing the engine before the oil reaches every part can cause engine seizure.

- If the motorcycle has just been used, run the engine for about 20 seconds at idle speed. Stop the engine and leave it one minute.

- Check the engine oil level through the oil level gauge in the lower right side of the engine. The oil level should come up between the upper and lower level.

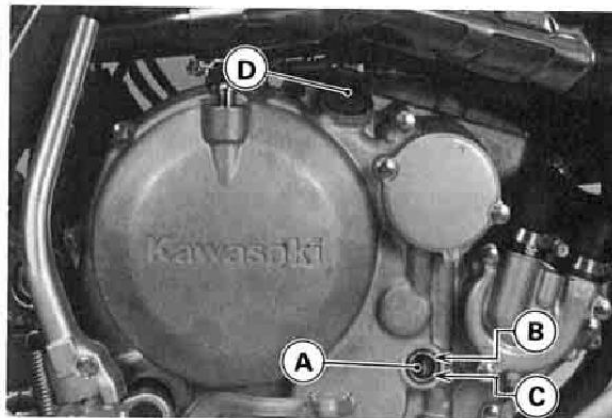

A. Oil Level Gauge
B. Upper Level

C. Lower Level
D. Oil Filler Cap

- ★ If the oil level is too high, remove the excess oil, using a syringe or some other suitable device.
- ★ If the oil level is too low, add the correct amount of oil through the oil filler opening. Use the same type and brand of oil that is already in the engine.

Oil and/or Oil Filter Change

- Warm up the engine thoroughly so that the oil will pick up any sediment and drain easily.
- Set the motorcycle up on its side stand.
- Stop the engine, and place an oil pan beneath the engine.
- Remove the engine and magneto flywheel cover drain plugs and position the vehicle so that it is perpendicular to the ground to allow all the oil to drain out.

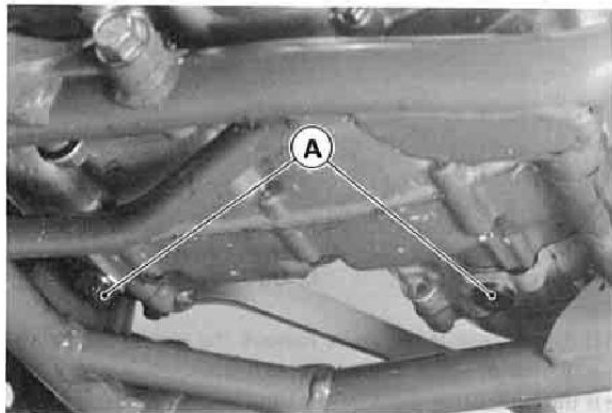

A. Drain Plugs

- If the oil filter is to be changed, remove the oil filter cover bolts and take off the cover with O-ring.

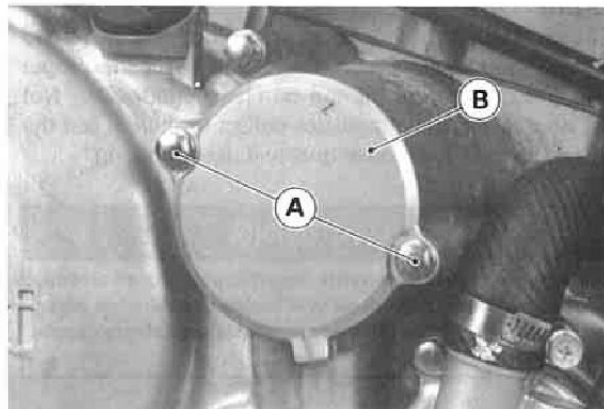

A. Bolts

B. Oil Filter Cover

- Pull off the element with the element mounting pin and collar.
- Remove the collar and pull the mounting pin off the element.
- Replace the element with a new one.
- Apply a little engine oil to the grommets on both side of the element, and push the mounting pin into the element. Be careful that the grommets do not slip out of place.
- Fit the collar in the element mounting pin hole of the crankcase.
- Install them with the smaller end of the pin inside.

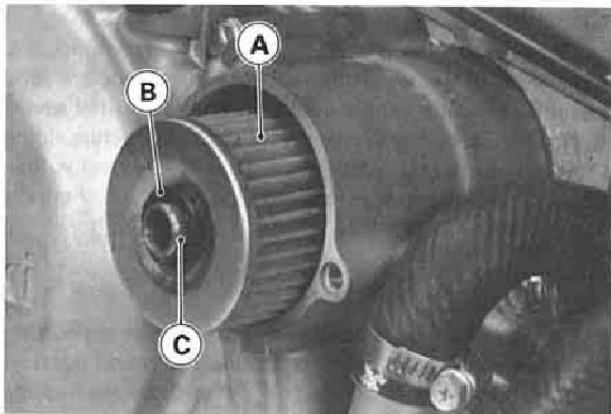

A. Element
B. Grommet

C. Mounting Pin

- Install the oil filter cover and tighten its bolts.
- After the oil has completely drained out, install the engine and magneto flywheel cover drain plugs with its gasket. Proper torque for it is shown in the table.

NOTE

- *Replace the damaged gasket with a new one.*
- Fill the engine up to the upper level with a good quality motor oil specified in the table.
- Check the oil level.

Tightening Torque (Drain Plug)

Engine:	29 N-m (3.0 kg-m, 22 ft-lb)
Magneto Flywheel Cover:	25 N-m (2.5 kg-m, 18 ft-lb)

Engine Oil

Grade:	SE, SF or SG class
Viscosity:	SAE 10W40, 10W50, 20W40, or 20W50
Capacity:	1.3 L (1.4 US qt)
	[when filter is not removed]
	1.3 L (1.4 US qt)
	[when filter is removed]
	1.5 L (1.6 US qt)
	[when engine is completely dry]

Cooling System

Radiator Hoses

Check the radiator hoses for cracks or deterioration, and connections for looseness in accordance with the Periodic Maintenance Chart.

Radiator

Check the radiator fins for obstruction by insects or mud. Clean off any obstructions with a stream of low-pressure water.

CAUTION

Using high-pressure water, as from a car wash facility, could damage the radiator fins and impair the radiator's effectiveness.

Do not obstruct or deflect airflow through the radiator by installing unauthorized accessories in front of the radiator. Interference with the radiator airflow can lead to overheating and consequent engine damage.

Coolant

Coolant absorbs excessive heat from the engine and transfers it to the air at the radiator. If the coolant level becomes low, the engine overheats and may suffer severe damage. Check the coolant level each day before riding the motorcycle and replenish coolant if the level is low. Change the coolant in accordance with the Periodic Maintenance Chart.

NOTE

○ A permanent type of antifreeze is installed in the cooling system when shipped. It is colored green and contains ethylene glycol. It is mixed at 50% and has the freezing point of -35°C (-31°F).

Coolant Level Inspection

● Check the coolant level through the coolant level gauge on the reserve tank located inside the left side cover. The coolant level should be between the FULL and LOW level lines.

NOTE

○ Check the level when the engine is cold (room or ambient temperature).

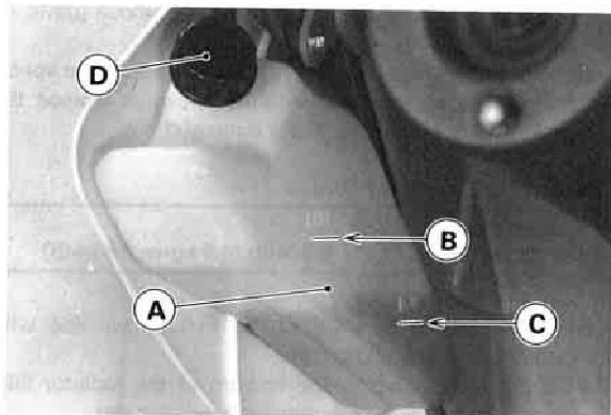

A. Reserve Tank
 B. FULL Level Line
 C. LOW Level Line
 D. Tank Cap

- If the amount of coolant is insufficient, unscrew the cap from the reserve tank and add coolant through the filler opening to the FULL level line.
- Install the cap.

Coolant

Water and coolant mixture ratio:

1 : 1 (Water 50%, Coolant 50%)

Recommended coolant:

Permanent type of antifreeze (soft water and ethylene glycol plus corrosion and rust inhibitor chemicals for aluminum engines and radiators)

Total amount: 1.9 L (2.0 US qt)

Coolant Change

The coolant should be changed periodically to ensure long engine life.

- Wait the engine to cool completely.
- Situate the motorcycle so that it is perpendicular to the ground.
- Remove the radiator cap.
- Place a container under the coolant drain plug, and drain the coolant from the radiator and engine by removing the drain plug at the water pump cover. Immediately wash out any coolant that spills on the frame, engine, or wheel.

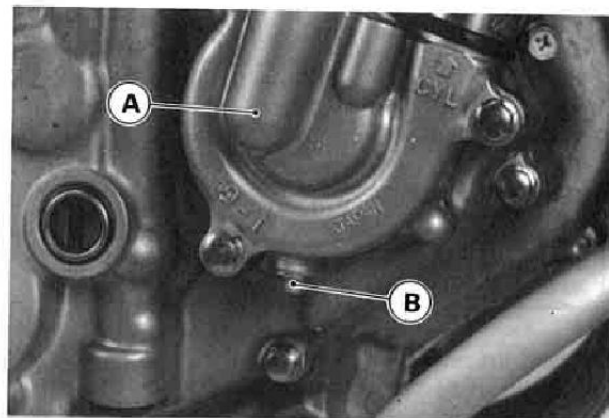

A. Water Pump Cover
 B. Drain Plug

- Remove the left side cover.
- Remove the reserve tank mounting bolts and take out the reserve tank from the frame.

- Unscrew the cap and pour the coolant into a container.

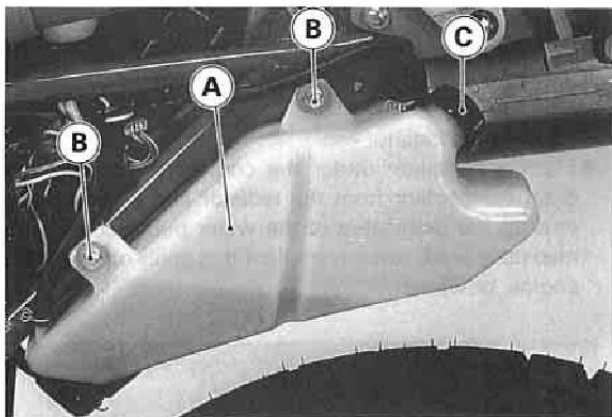

A. Reserve Tank
B. Mounting Bolt

C. Cap

⚠ WARNING

Coolant on tires will make them slippery and can cause an accident and injury.

- Install the reserve tank on the frame.
- Visually inspect the old coolant. If whitish cotton-like wafts are observed, aluminum parts in the cooling system are corroded. If the coolant is brown, iron or steel parts are rusting. In either case, flush the cooling system.

- Check the cooling system for damage, loose joints, or leaks.
- Install the water pump cover drain plug with the specified torque shown in the table. Always replace the gasket with a new one, if it is damaged.

Drain Plug Tightening Torque

Water Pump Cover Drain Plug:	8.8 N-m (0.9 kg-m, 78 in-lb)
---	-------------------------------------

- Fill the reserve tank up to the FULL level line with coolant, and install the cap.
- Fill the radiator up to the bottom of the radiator filler neck with coolant, and install the radiator cap.
- Check the cooling system for leaks.
- Start the engine, warm up the engine thoroughly, then stop the engine.
- Check the coolant level in the reserve tank after the engine cools down. If the coolant level is low, add coolant up to the FULL level line.
- Install the left side cover.

Spark Plug

The standard spark plug is an NGK DPR8EA-9 or ND X24EPR-U9. It should have a 0.8 – 0.9 mm (0.032 – 0.036 in) gap, and be tightened to 14 N·m (1.4 kg·m, 10 ft·lb) of torque.

Spark Plug Gap

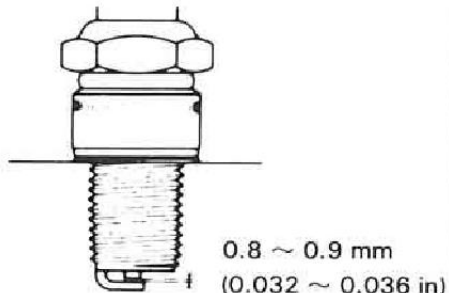

The spark plug should be taken out periodically to check its gap and ceramic insulator. If the plug is oily or has carbon built up on it, clean it (preferably with a sandblaster) and then clean off any abrasive particles. The plug may also be cleaned using a high flash-point solvent and a wire brush or other suitable tool. Measure the gap with a wire-type thickness gage. Adjust the gap, if incorrect, by bending the outer electrode. If the spark plug electrodes are corroded, worn or damaged, or if insulator is cracked, replace the plug. Use the standard plug.

Valve Clearance

Valve and valve seat wear decrease valve clearance, upsetting valve timing.

CAUTION

If valve clearance is left unadjusted, the wear will eventually cause the valves to remain partly open; which lowers performance, burns the valves and valve seats, and may cause serious engine damage.

Valve clearance for each valve should be checked and adjusted in accordance with the Periodic Maintenance Chart. Inspection and adjustment should be done only by a competent mechanic following the instructions in the Service Manual.

Air Cleaner

A clogged air cleaner restricts the engine's air intake, increasing fuel consumption, reducing engine power, and causing spark plug fouling.

⚠ WARNING

A clogged air cleaner may allow dirt and dust to enter the carburetor and stick the throttle open. This could cause an accident.

CAUTION

A clogged air cleaner may allow dirt and dust to enter the engine causing excessive wear and possible engine damage.

The air cleaner element must be cleaned in accordance with the Periodic Maintenance Chart.

Element Removal

- Remove the seat and take out the air cleaner intake cap.
- Remove the wing bolt, and take out the element.

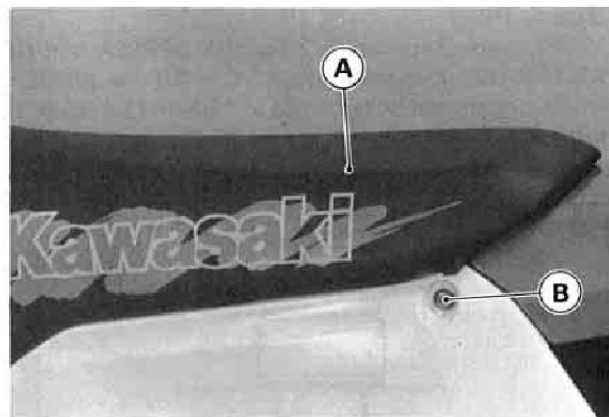

A. Seat

B. Seat Mounting Bolt

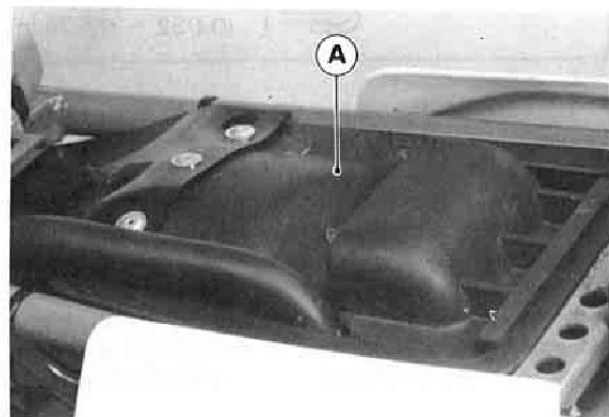

A. Air Cleaner Intake Cap

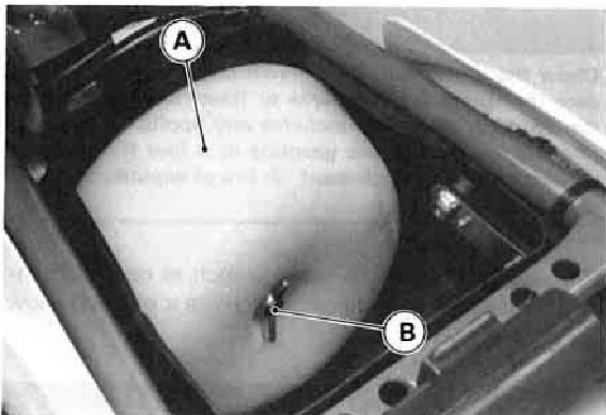

A. Element

B. Wing Bolt

Element Cleaning

- Check inside the inlet tract and carburetor for dirt. If dirt is present, clean the intake tract and carburetor thoroughly. You may also need to replace the air cleaner element and seal the air cleaner housing and inlet tract.
- Stuff a clean, lint-free towel into the carburetor so not dirt is allowed to enter the carburetor.
- Wipe out the inside of the air cleaner housing with a clean damp towel.
- Take off the element from the frame.

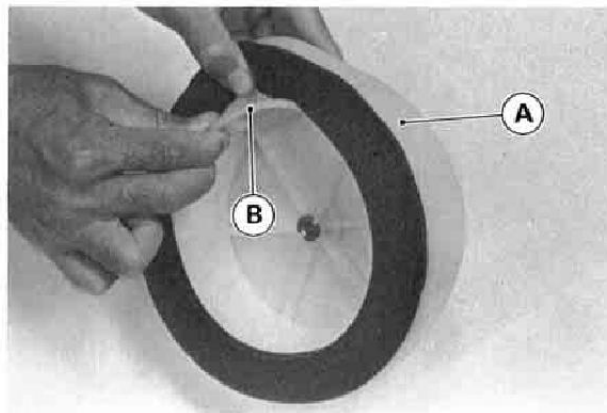

A. Element

B. Frame

CAUTION

Do not twist or wring the element, as it can easily be torn or otherwise damaged.

- Clean the element in a bath of a high flash-point solvent using a soft bristle brush. Squeeze it dry in a clean towel. Do not wring the element or blow it dry; the element can be damaged.



⚠ WARNING

Clean the element in a well-ventilated area, and take care that there are no sparks or flame anywhere near the working area; this includes any appliance with a pilot light. Do not use gasoline or a low flash-point solvent to clean the element. A fire or explosion could result.

- Inspect the element for damage such as tears, hardening, or shrinkage. If damaged, replace it or it will allow dirt into the carburetor.

⚠ WARNING

If dirt or dust is allowed to pass through into the carburetor, the throttle may become stuck, possibly causing an accident.

CAUTION

If dirt gets through into the engine, excessive engine wear and possibly engine damage will occur.

- After cleaning, saturate the element with a high-quality foam-air-filter oil, squeeze out the excess oil, then wrap it in a clean rag and squeeze it as dry as possible. Be careful not to tear the element.
- Apply grease to all connections and screw hole in the air cleaner housing and intake tract.
- Remove the towel from the carburetor.

- Install the element on the frame, coat the lip of the element with a thick layer of all purpose grease to assure a complete seal against the element base. Also, coat the base where the lip of the element fits.

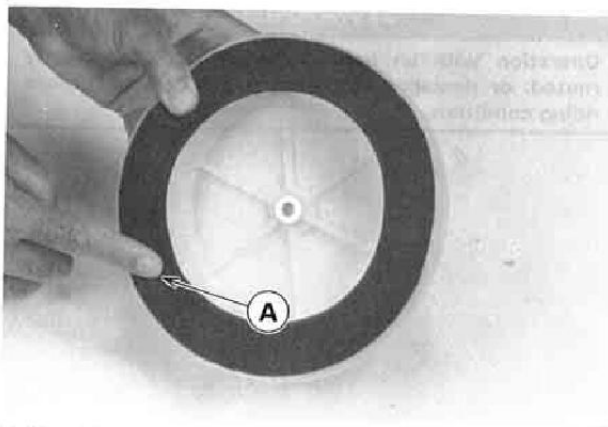

A. Grease

- Install the element in the machine, and make sure the sealing surface of the element is seated properly.
- Install the air cleaner intake cap and seat.

Throttle Cable

Inspect the throttle grip for smooth operation in all steering positions. In accordance with the Periodic Maintenance Chart check and adjust the throttle cable.

- Check that the throttle grip has 2 – 3 mm (0.08 – 0.12 in) of play and turns smoothly.

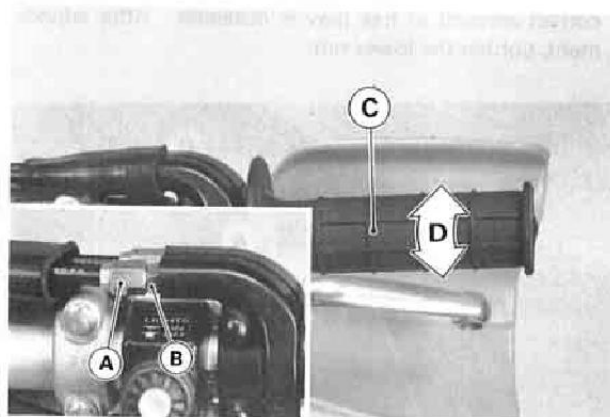

A. Adjuster
B. Locknut

C. Throttle Grip
D. 2 – 3 mm (0.08 – 0.12 in)

- ★ If the play is incorrect, loosen the locknut on the upper end of the throttle cable, and turn the adjuster to obtain the correct amount of play. Tighten the locknut.

★ If the free play cannot be set by adjusting the upper cable adjuster, use the nuts on the accelerator cable at the carburetor.

- Loosen the locknut at the throttle grip and turn in the adjuster fully. Tighten the locknut.
- Loosen the upper nut and turn out the lower nut on the accelerator cable, then turn in the upper nut until the correct amount of free play is obtained. After adjustment, tighten the lower nut.

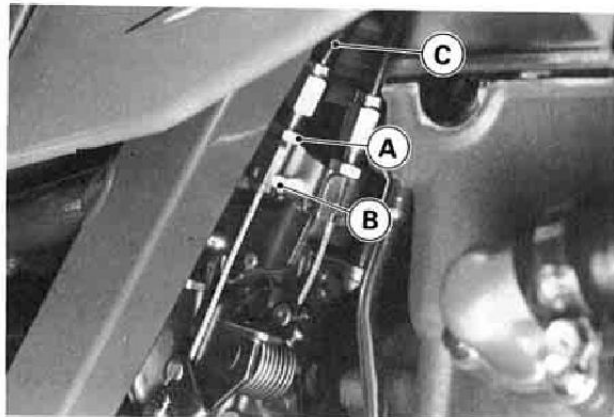

A. Upper Nut
B. Lower Nut

C. Accelerator Cable

- If there is excess play, use the adjuster at the throttle grip.

⚠ WARNING

Operation with an improperly adjusted, incorrectly routed, or damaged cable could result in an unsafe riding condition.

Carburetor

Idling Adjustment

Idling adjustment is carried out using the idle adjusting screw.

- After thoroughly warming up the engine, turn the idle adjusting screw to obtain the desired idle speed. If no idle is preferred, turn out the screw until the engine stops.

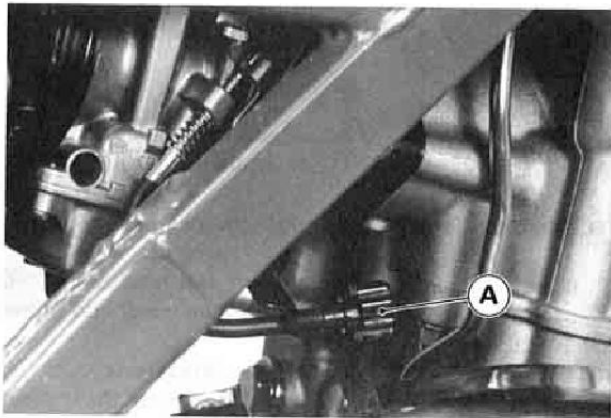

A. Idle Adjusting Screw

- Open and close the throttle a few times to make sure the idle speed does not change. Readjust if necessary.
- With the engine idling, turn the handlebar to each side. If handlebar movement changes the idle speed, the throttle cable may be improperly adjusted or incorrectly routed, or it may be damaged. Be sure to correct any of these conditions before riding.

⚠ WARNING

Operation with a damaged cable could result in an unsafe riding condition.

Clutch

Proper clutch lever play is 10 – 20 mm (0.4 – 0.8 in). The play increases with cable stretch and friction plate wear, necessitating adjustment.

When there is too much lever play, first try adjusting the cable at the clutch lever.

- Slide the clutch lever dust cover out of place.
- Loosen the knurled locknut, turn the adjuster to obtain the proper amount of lever play, and tighten the locknut.

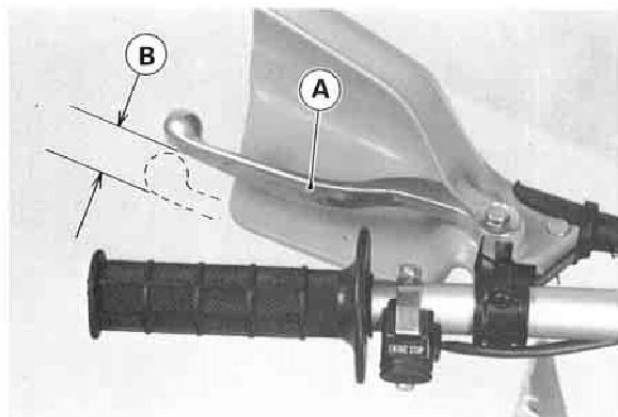

A. Clutch Lever

B. 10 – 20 mm (0.4 – 0.8 in)

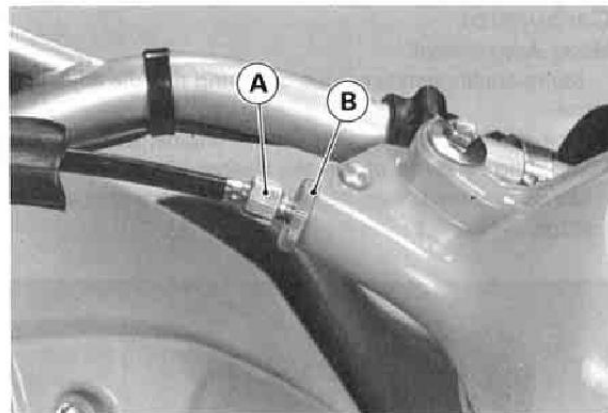

A. Adjuster

B. Knurled Locknut

- Slide back the clutch lever dust cover.

If the adjuster at the clutch lever has reached its limit, adjust the cable with the adjuster at the lower end of the clutch cable.

- Loosen the knurled locknut at the clutch lever.
- Turn the adjuster in all the way, then tighten the knurled locknut.
- Loosen the nuts at the lower end of the cable, and move the adjuster so that the clutch lever has 10 – 20 mm (0.4 – 0.8 in) of play.

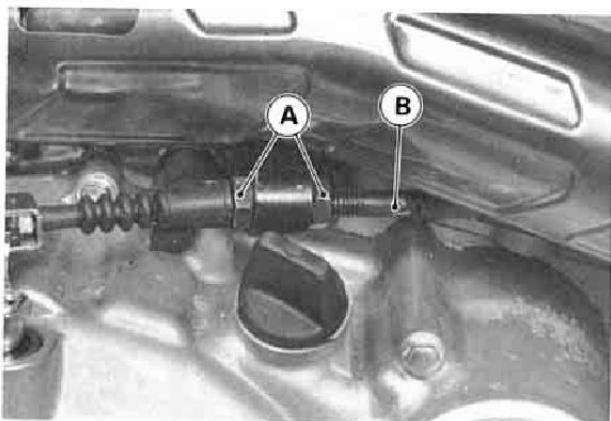

A. Nuts

B. Adjuster

- Tighten the nuts.
- Slide the dust cover back into place.
- After the adjustment is made, start the engine and check that the clutch does not slip and that it releases properly.

Spark Arrester

This vehicle is equipped with a spark arrester. It must be properly maintained to ensure its efficiency. In accordance with the Periodic Maintenance Chart, clean the spark arrester.

CAUTION

The spark arrester must be installed correctly and functioning properly to provide adequate fire protection.

Spark Arrester Cleaning

⚠ WARNING

To avoid burns, be sure the exhaust system is cold before cleaning the spark arrester. The exhaust system becomes very hot soon after the engine is started.

- Remove the right side cover.
- Remove the spark arrester mounting bolts and take the spark arrester off from the muffler rear end.

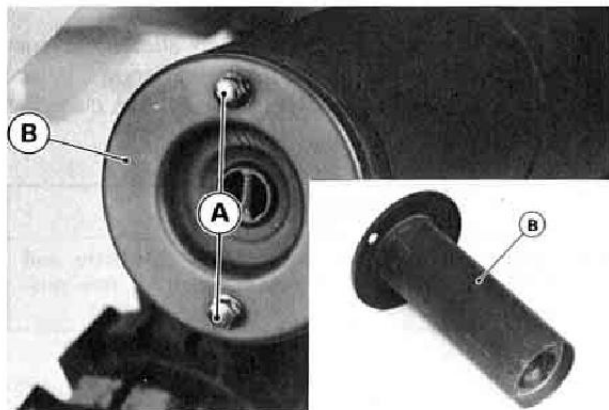

A. Mounting Bolts

B. Spark Arrester

- Loosen the exhaust pipe clamp bolt.
- Remove the muffler mounting bolts and pull the muffler off toward the rear.

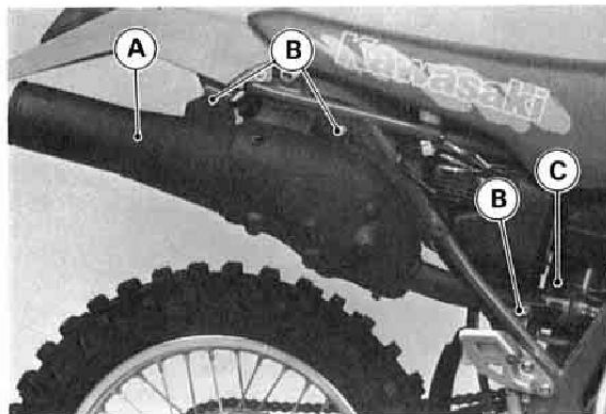

A. Muffler

C. Clamp Bolt

B. Mounting Bolts

- With a wire brush, remove the carbon off the inside of the spark arrester and muffler.
- Install the muffler and tighten the mounting bolts and clamp bolt securely.
- Install the spark arrester into the rear end of the muffler.
- Install the right side cover.

Drive Chain

The drive chain must be checked, adjusted, and lubricated in accordance with the Periodic Maintenance Chart for safety and to prevent excessive wear. If the chain becomes badly worn or maladjusted – either too loose or too tight – the chain could jump off the sprockets or break.

⚠ WARNING

A chain that breaks or jumps off the sprockets could snag on the engine sprocket or lock the rear wheel, severely damaging the motorcycle and causing it to go out of control.

Slack Inspection

With the motorcycle on the side stand, push up the drive chain in the middle of the upper run to measure the chain play. The space between the chain and the swing arm at the rear of the chain slipper should be 55 – 70 mm (2.2 – 2.8 in). Rotate the rear wheel to find the place where the chain is tightest (because it wears unevenly). Adjust the drive chain if it has too much or too little slack.

In addition to checking the slack, rotate the rear wheel to inspect the drive chain and sprockets for damaged rollers, loose pin and links, unevenly or excessively worn teeth, and damaged teeth.

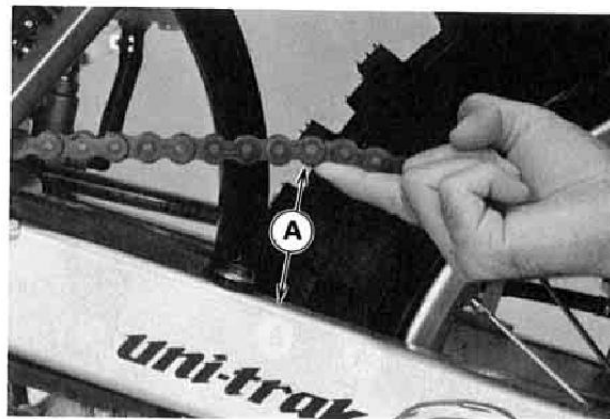

A. 55 – 70 mm (2.2 – 2.8 in)

If there is any irregularity, replace the drive chain and/or sprockets.

Slack Adjustment

- Remove the cotter pin, and loosen the rear axle nut.
- Rotate the chain adjuster at each end of the swingarm to obtain the specified chain slack.

Standard Chain Slack

55 – 65 mm (2.2 – 2.6 in)

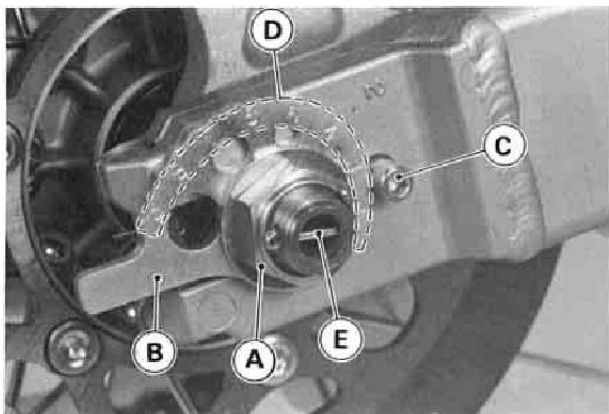

- A. Axle Nut
 B. Chain Adjuster
 C. Projection
 D. Numbers
 E. Cotter Pin

NOTE

- Wheel alignment can also be checked using the straightedge or string method.

⚠ WARNING

Misalignment of the wheel will result in abnormal wear and may result in an unsafe riding condition.

- Tighten the axle nut to 98 N-m (10 kg-m, 72 ft-lb) of torque.
- Rotate the wheel, measure the chain slack again at the tightest position, and readjust if necessary.

- Insert a new cotter pin through the axle, and spread its ends.

⚠ WARNING

If the axle nut is not securely tightened, or the cotter pin is not installed, an unsafe riding condition may result.

NOTE

- In wet and muddy conditions, mud sticks to the chain and sprockets resulting in an overly tight chain, and the chain may break. To prevent this, adjust the chain to 60 – 70 mm (2.4 – 2.8 in) of space between the chain and swingarm whenever necessary.

Drive Chain, Chain Guide, Chain Slipper and Sprocket Wear Inspection

When the chain has worn so much that it is more than 2% longer than when new, it is no longer safe for use and should be replaced. Whenever the chain is replaced, inspect both the engine and rear sprockets, and replace them if necessary. Overworn sprockets will cause a new chain to wear quickly.

Drive Chain Wear

Since it is impractical to measure the entire length of the chain, determine the degree of wear by measuring a 20-link length of the chain. Stretch the chain taut either by using the chain adjuster, or by hanging a 10 kg (20 lb) weight on the chain. Measure the length of 20 links on a straight part of the chain from the center of the 1st pin to the center of the 21st pin. If the length is greater than the service limit, the chain should be replaced.

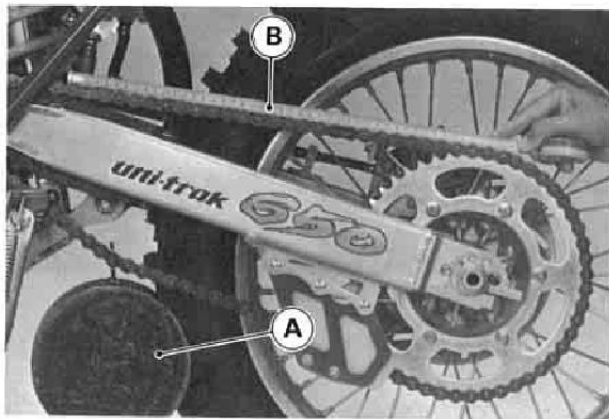

A. Weight

B. Measure

Drive Chain Length

Standard	Service Limit
317.5 mm (12.5 in)	323 mm (12.7 in)

NOTE

- *The drive system was designed for use with a DAIDO D.I.D 520VL2 110 link chain. For maximum stretch resistance and safety, a genuine part must be used for replacement.*
- *To minimize any chance of the master link coming apart, the master link clip must be installed with the closed end of the "U" pointed in the direction of chain rotation.*

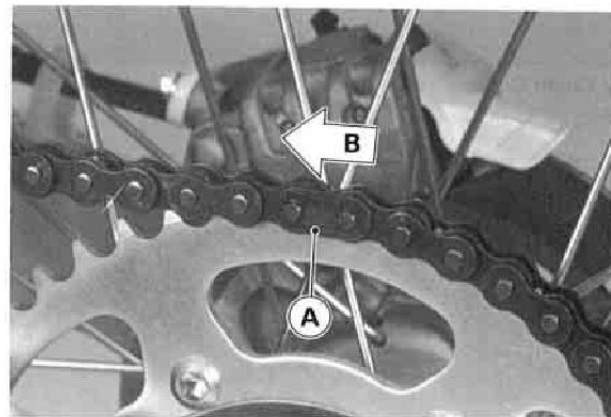

A. Clip

B. Direction of Chain Rotation

Chain Guide Wear

Visually inspect the drive chain guide. If the guide is worn excessively or damaged, replace it.

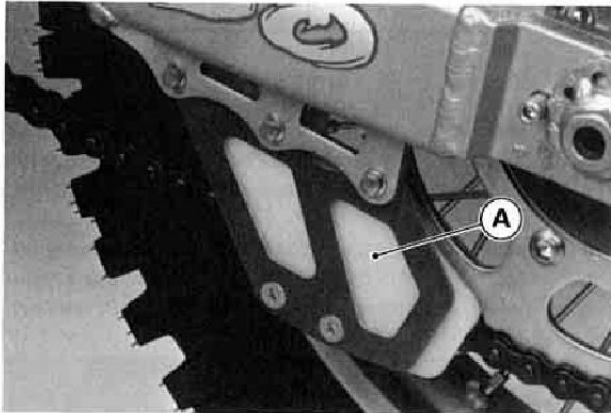

A. Chain Guide

Chain Slipper Wear

Visually inspect the upper and lower chain slippers on the swingarm. If the chain slipper is worn or damaged, replace it.

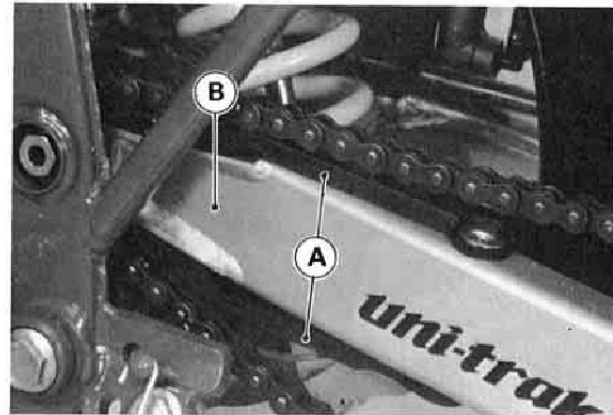

A. Chain Slippers

B. Swingarm

Sprocket Wear

Visually inspect the sprocket teeth. If they are worn or damaged, replace the sprocket.

NOTE

Sprocket wear is exaggerated for illustration.

Sprocket

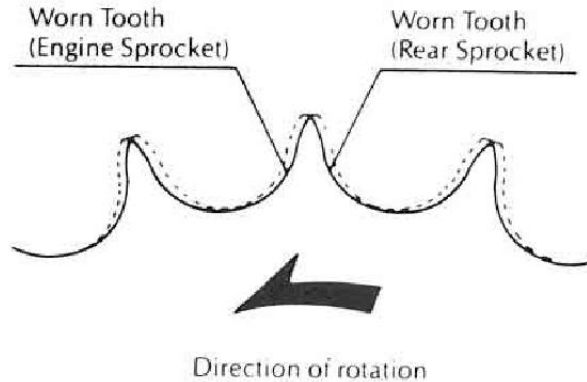

Lubrication

Lubrication is necessary after riding through rain or in the mud, or any time that the chain appears dry. A heavy oil such as SAE90 is preferred to a lighter oil because it will stay on the chain longer and provide better lubrication.

- Apply oil to the side of the rollers so that it will penetrate to the rollers and bushings. Apply oil to the O-rings so that the O-rings will be coated with oil. Wipe off any excess oil.

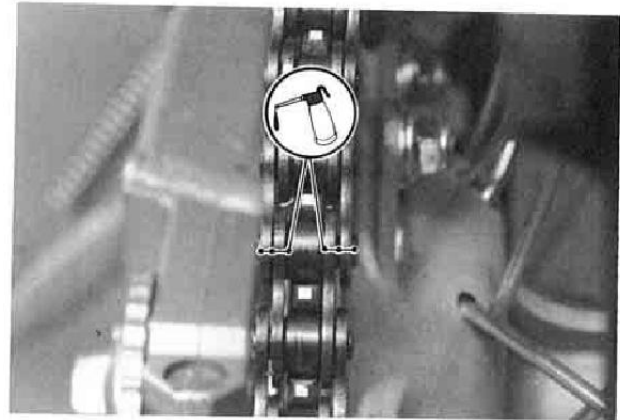

- If the chain is especially dirty, clean it using diesel oil or kerosene and then apply oil as mentioned above.

Handlebar

To suit various riding positions, the handlebar position can be adjusted by handlebar holder turn front to rear.

Handlebar Position Adjustment

- Remove the handlebar clamp and bolts, and take off the meter unit and handlebar.
- Loosen the handlebar holder nuts, turn about the handlebar holder, and tighten the nuts securely.

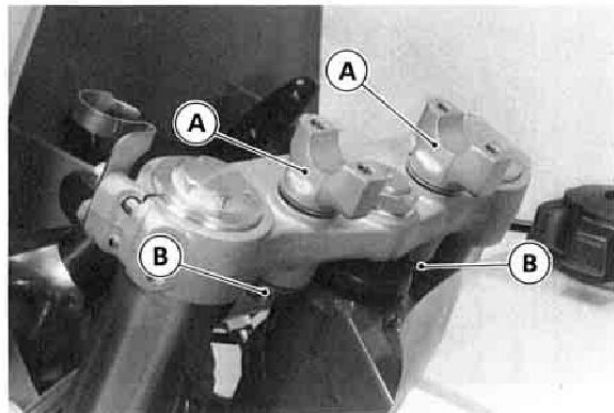

A. Handlebar Holder

B. Nut

- Put the handlebar on the handlebar holder.
- Mount the clamp so that the arrow on the clamp points at the front.

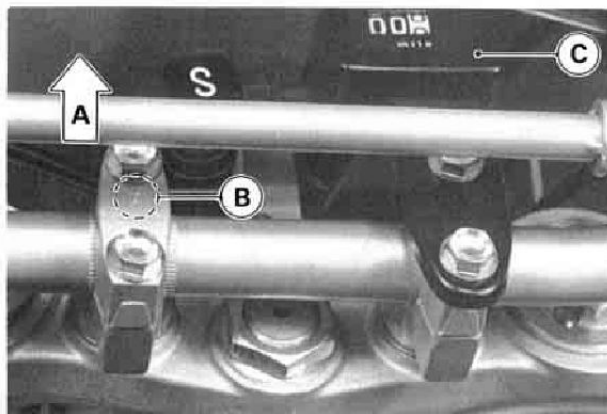

A. Front
B. Arrow

C. Meter Unit

- Put the meter unit on the right clamp.
- Tighten the clamp bolts, front first and then rear, to 25 N-m (2.5 kg-m, 18 ft-lb) of torque. If the handlebar clamp is correctly installed, there will be no gap at the front and an even gap at the rear after tightening.

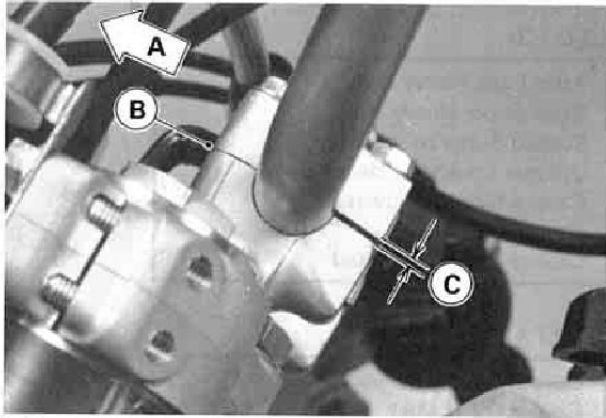

A. Front
B. No Gap

C. Gap

Brakes

Disc and disc pad wear is automatically compensated for and has no effect on the brake lever or pedal action. So there are no parts that require adjustment on the brakes except brake lever play.

Front Brake Lever Play:

Adjust the front brake lever to suit you. To adjust the brake lever play, loosen the locknut and turn the adjuster to either side. After adjustment, tighten the locknut securely.

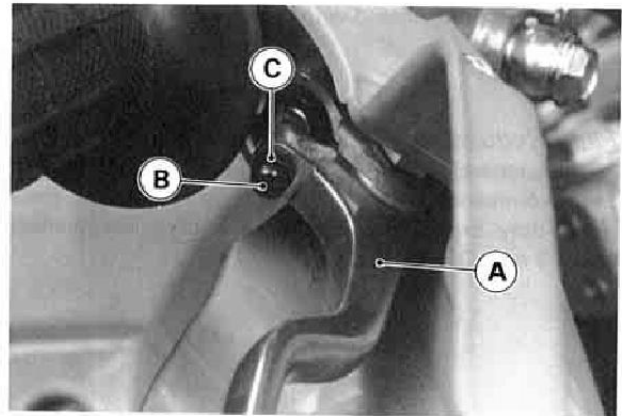

A. Brake Lever
B. Adjuster

C. Locknut

⚠ WARNING

If the brake lever or pedal feels mushy when it is applied, there might be air in the brake lines or the brake may be defective. Since it is dangerous to operate the motorcycle under such conditions, have the brake checked immediately.

Disc Brake Fluid:

In accordance with the Periodic Maintenance Chart, inspect the brake fluid level in the reservoirs and change the brake fluid. The brake fluid should also be changed if it becomes contaminated with dirt or water.

Fluid Requirement

Recommended fluid are given in the table. If none of the recommended brake fluids are available, use extra heavy-duty brake fluid only from a container marked D.O.T.3 or D.O.T.4.

Recommended Disc Brake Fluid (D.O.T.3)

Atlas Extra Heavy Duty
Shell Super Heavy Duty
Texaco Super heavy Duty
Wagner Lockheed Heavy Duty
Castrol Girling-Universal
Castrol GT (LMA)
Castrol Disc Brake Fluid

(D.O.T.4)

Castrol Girling-Universal
Castrol GT (LMA)
Castrol Disc Brake Fluid
Check Shock Premium Heavy Duty

NOTE

○ *Brake fluid of D.O.T.4 is installed in the brake system when shipped.*

Fluid Level Inspection

● With the reservoirs held horizontal, the brake fluid level must be kept more than half full with brake fluid (front reservoir) and between the upper and lower level lines (rear reservoir).

If the amount of brake fluid is insufficient, add brake fluid.

CAUTION

Do not spill brake fluid onto any painted surface.
Do not use fluid from a container that has been left open or that has been unsealed for a long time.
Check for fluid leakage around the fittings.
Check for brake hose damage.

⚠ WARNING

Do not mix two brands of fluid. Change the brake fluid in the brake line completely if the brake fluid must be refilled but the type and brand of the brake fluid already in the reservoirs are unidentified.

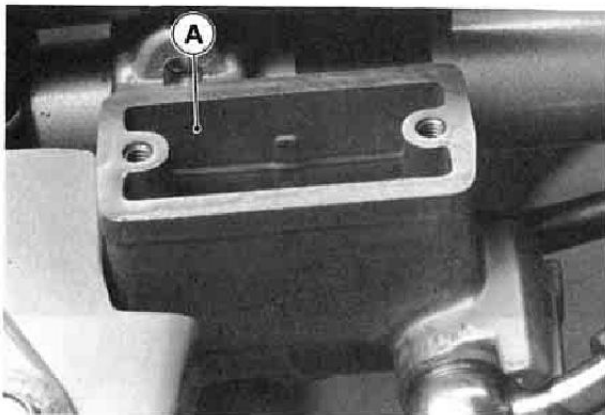

A. Front Reservoir

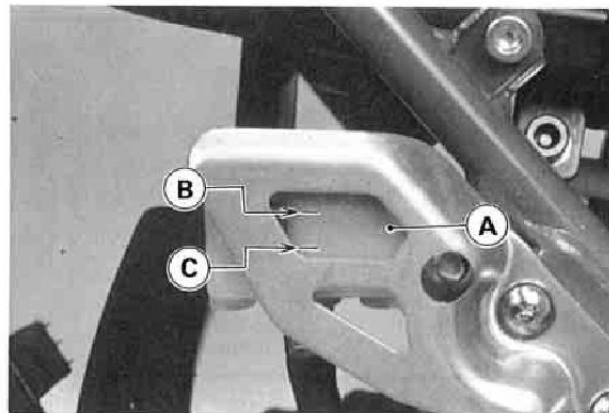

A. Rear Reservoir

B. Upper Level

C. Lower Level

Brake Wear Inspection:

In accordance with the Periodic Maintenance Chart, inspect the brakes for wear. For each front and rear disc brake caliper, if the thickness of either pad is less than 1 mm (0.04 in), replace both pads in the caliper as a set. Pad replacement should be done by an authorized Kawasaki dealer.

Pad Usable Range

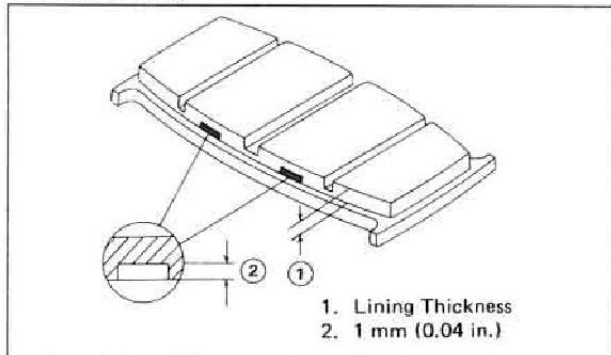

Steering

The steering should always be kept adjusted so that the handlebar will turn freely but not have excessive play.

To check the steering adjustment, using the jack (special tool), raise the front wheel off the ground. Push the handlebar lightly to either side; if it continues moving under its own momentum, the steering is not too tight. Squatting in front of the motorcycle, grasp the lower ends of the front fork at the axle, and push and pull the bottom end of the front fork back and forth; if play is felt, the steering is too loose.

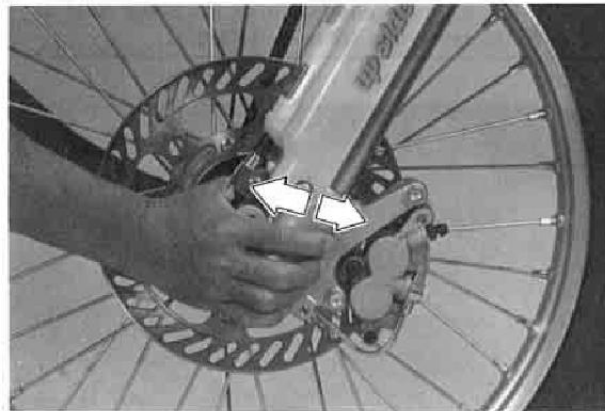

If the steering needs adjusting:

- Remove the headlight unit, choke knob unit and meter unit.
- Using the jack (special tool), raise the front wheel off the ground.
- Loosen the front fork upper clamp bolts.
- Remove the handlebar.
- Remove the steering stem head nut and washer, and take off the steering stem head.

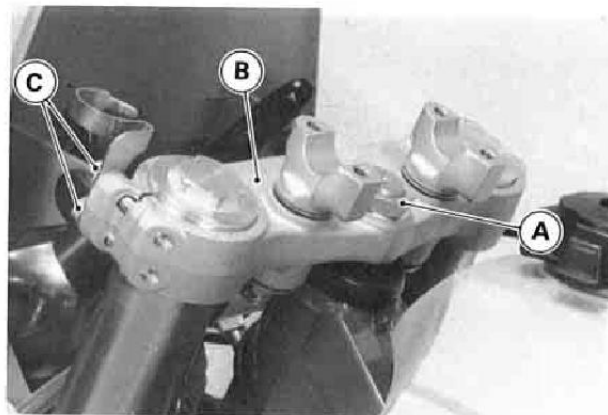

- A. Stem Head Nut
- B. Stem Head
- C. Front Fork Upper Clamp Bolts

- Turn the steering stem locknut with the stem nut wrench (special tool) to obtain the proper adjustment.

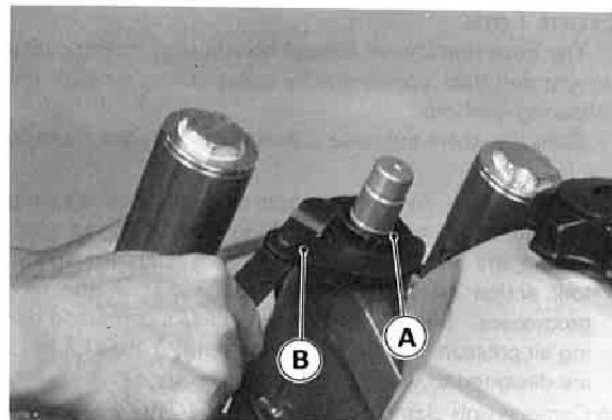

- A. Stem Locknut
- B. Stem Nut Wrench: 57001-1100

- Install the stem head.
- Tighten the steering stem head nut to 44 N-m (4.5 kg-m, 33 ft-lb) of torque and front fork upper clamp bolts to 20 N-m (2.0 kg-m, 14.5 ft-lb) of torque.
- Check the steering again, and readjust it if necessary.
- Install the handlebar.
- Install the headlight unit, choke knob unit and meter unit.

Front Fork

The front fork should always be adjusted for the rider's weight and track conditions by using one or more of the following methods.

Basically, there are three adjustments you can make to the front fork.

- ★ **Air pressure** – Air pressure acts as a progressive spring and affects the entire range of fork travel. The air pressure in the fork increases as the fork heats up, so the fork action on your KLX will get stiffer as the race progresses. Because of this, we don't recommend using air pressure for additional springing. Your KLX forks are designed to work without adding any air.
- ★ **Compression damping adjustment** – This adjustment affects how quickly the compresses. The fork compression damping adjuster has 16 clicks. The seated position (full clockwise until the adjuster stops) is full hard. From the point, 13 clicks counterclockwise is the standard setting, and 16 clicks (full counterclockwise until the adjuster stops) is full soft.
- ★ **Oil level adjustment** – The effects of higher or lower fork oil level are only felt during the final 100 mm (4 in) of fork travel. A higher oil level (more oil) will make the fork rebound more quickly. A lower oil level (less oil) will make the fork rebound more slowly.
- ★ **Fork spring** – Optional springs are available that are softer and stiffer than standard.

Air Pressure:

The standard air pressure in the front fork legs is atmospheric pressure. The air pressure in the fork legs increases as the fork heats up, so the fork action will get stiffer as the vehicle operation progresses.

- Using the jack (special tool), raise the front wheel off the ground.
- Remove the screws at the top of the front fork top bolts to let the air pressure equalize. Then reinstall them.

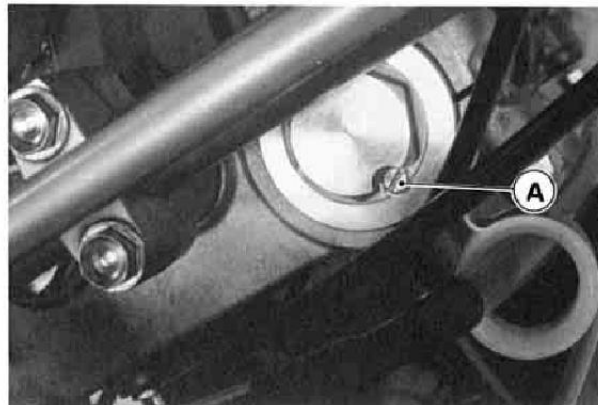

A. Screw

Compression Damping Adjustment:

- Clean the bottom of the fork tubes.
- Remove the caps on the bottom of the fork tubes.
- To adjust compression damping, turn the adjuster on the front fork cylinder valve with the blade of a screwdriver until you feel a click. Adjust the compression damping to suit your preference under special condition.

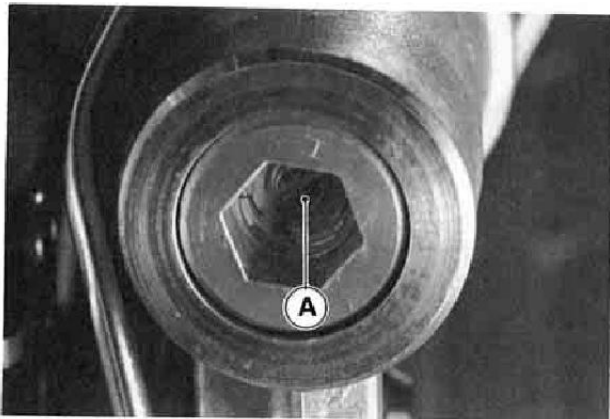

A. Adjuster

CAUTION

The left and right fork legs must have the same shock damping.

Compression Damping Adjustment

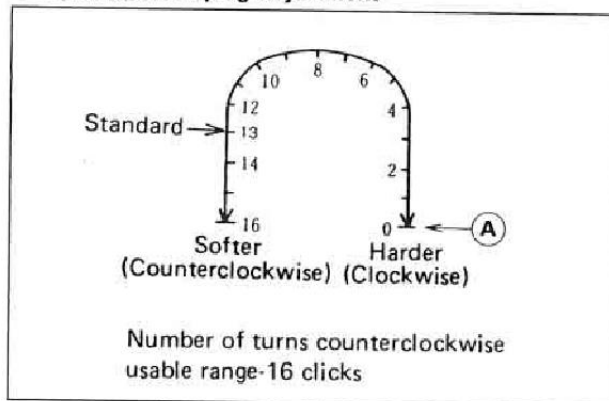

A. Seated position with adjuster turned fully clockwise.

- Put the caps into the bottom of the fork tubes.

Oil Level Adjustment:

- Using the jack (special tool), raise the front wheel off the ground.
- Remove the following parts.
 - Front Fender
 - Meter Cable Lower End
 - Headlight Unit
 - Meter Unit (with Meter Cable)
 - Handlebar
 - Choke Knob Unit
- Remove the front fork protectors.

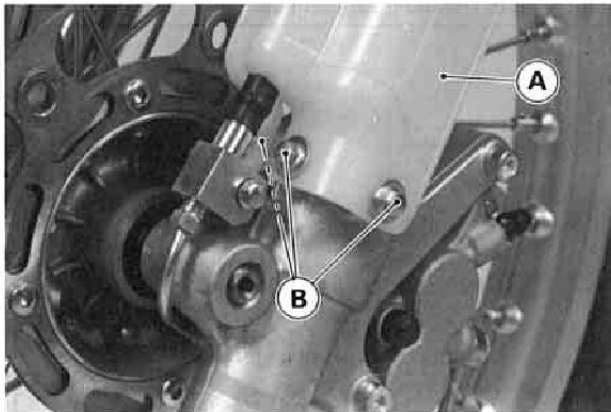

A. Front Fork Protector
B. Mounting Bolts

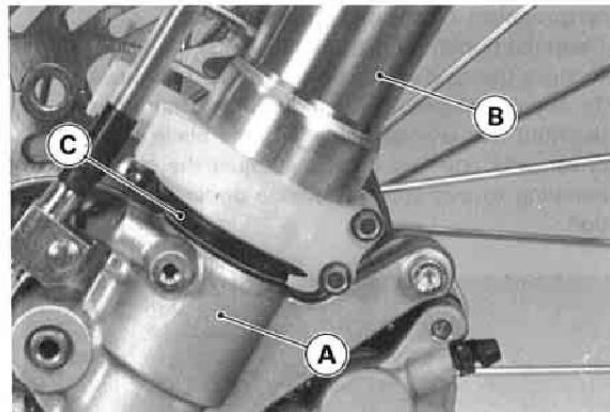

A. Inner Tube **C. Dust Cover**
B. Outer Tube

- Loosen the fork upper clamp bolts.
- Remove the top bolts from the top of the fork tubes.
- Slowly compress front fork fully while pushing up the inner tube lower end (touch a stepped portion of the inner tube to the outer tube dust cover lower end), and place a stand or other suitable support under the front wheel.

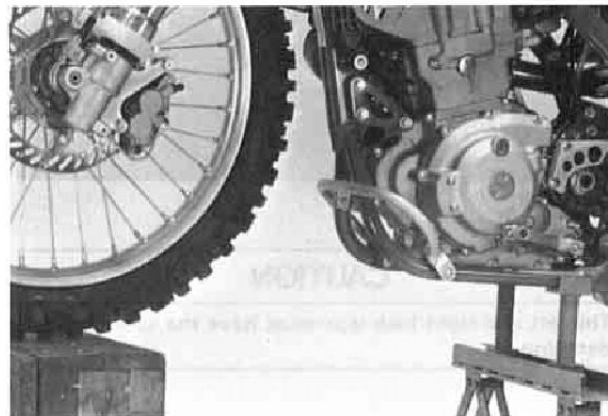

- Pull down the fork spring and insert the spring holder (special tool) under the push rod nut.

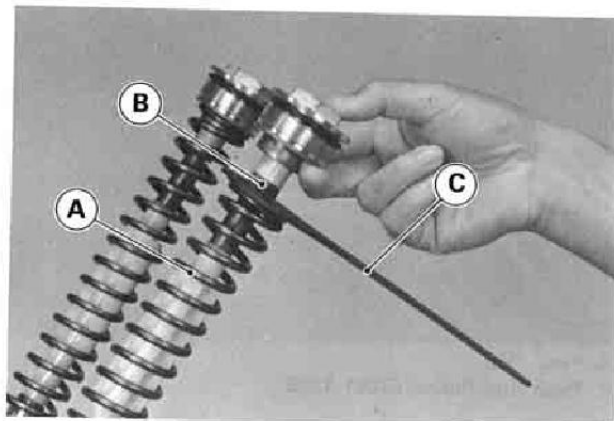

A. Spring
B. Push Rod Nut
C. Spring Holder:
57001-1286

- Remove the top bolt from the top of the push rod.
- Remove the spring seat.
- Take the spring holder (special tool) off and pull out the fork spring.

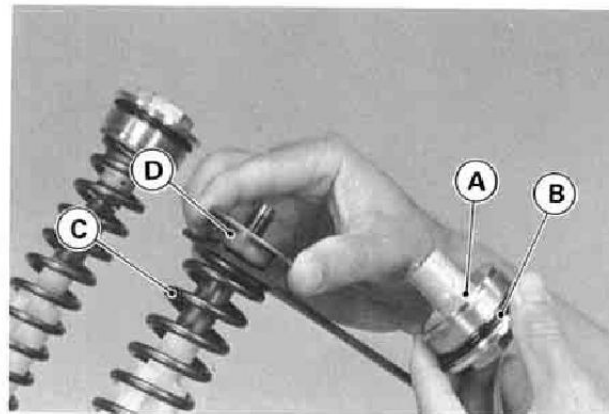

A. Top Bolt
B. O-Ring
C. Spring
D. Spring Seat

- Remove the other fork spring.
- Put the oil level gauge (special tool) on the top of the fork tube, and measure the distance from the top of the fork tube to the oil level.

Standard Oil Level:

90 mm (3.54 in)

Adjustable Range:

75 – 105 mm (2.95 – 4.13 in)

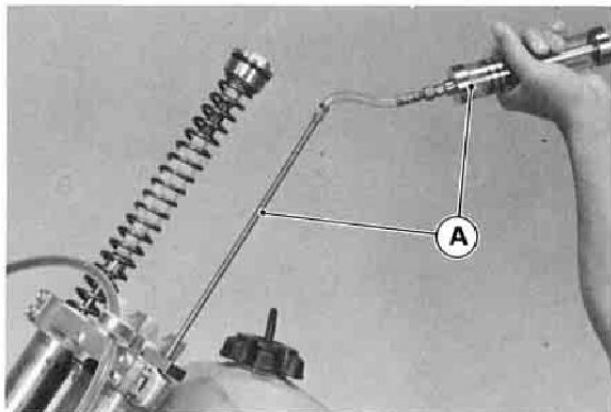

A. Oil Level Gauge: 57001-1290

- Adjust the oil level as required within the adjustable range using the following oil.

Recommended Oil: KAYABA 01 or SAE 5W

- Screw in the push rod puller (special tool) onto the push rod.

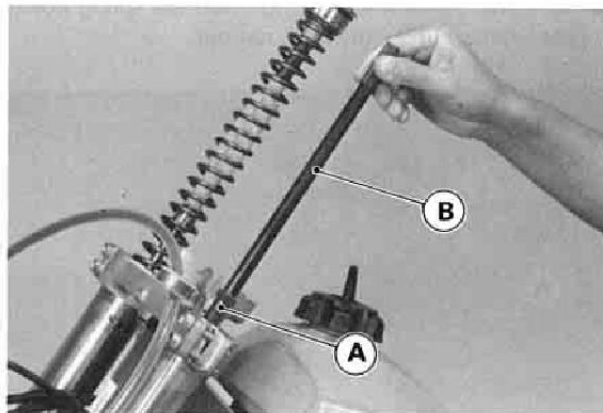

A. Push Rod

B. Push Rod Puller: 57001-1298

- Put the fork spring into the fork tube.
- Pull up the push rod slowly.
- Pull down the fork spring and insert the spring holder (special tool) under the push rod nut.

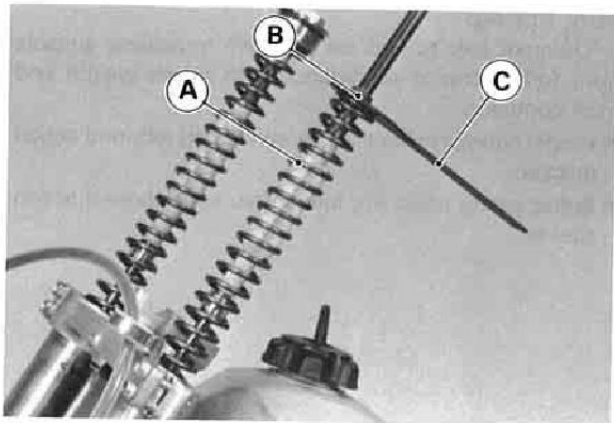

A. Spring
 B. Push Rod Nut
 C. Spring Holder
 57001-1286

- Remove the push rod puller.
- Put the spring seat on the fork spring.

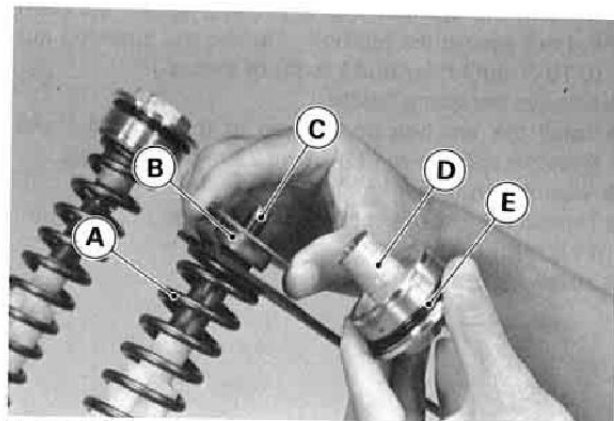

A. Fork Spring
 B. Spring Seat
 C. Push Rod
 D. Top Bolt
 E. O-Ring

- Check the O-ring of the top bolt for damage. If necessary, replace it with a new one.
- Install the top bolt onto the push rod.

- Holding the top bolt with a wrench, tighten the push rod nut against the top bolt. Tighten the push rod nut to 15 N-m (1.5 kg-m, 11 ft-lb) of torque.
- Remove the spring holder.
- Install the top bolt on the top of the fork tube and tighten it to 29 N-m (3.0 kg-m, 22 ft-lb) of torque.
- Assemble the other fork tube.
- Tighten the fork upper clamp bolt to 20 N-m (2.0 kg-m, 14.5 ft-lb) of torque.
- Install the parts removed.

Fork Spring:

Different fork springs are available to achieve suitable front fork action in accordance with rider's weight and track condition.

- ★ Harder springs make the fork stiffer, and rebound action quicker.
- ★ Softer spring make the fork softer, and rebound action slower.

Rear Suspension (Uni-Trak)

The rear suspension system of this motorcycle is Uni-trak. It consists of a rear shock absorber, swingarm, tie rod and rocker arm.

In general the operating characteristics of the Uni-trak are similar to the front fork. But, in achieving progressive spring characteristics a linkage system is used.

To suit to various riding conditions, the spring preload of the shock absorber can be adjusted or the spring can be replaced with an optional one. Also the damping force can be adjusted easily so changing oil viscosity is unnecessary.

Shock Damping Adjustment: Rear Shock Absorber

Rebound Damping Adjustment

To adjust shock rebound damping, turn the rebound damping adjuster on the rear shock absorber lower end with the blade of a screwdriver until you feel a click.

If the damper setting feels too soft or too stiff, adjust it in accordance with the following table:

Rebound Damping Adjustment

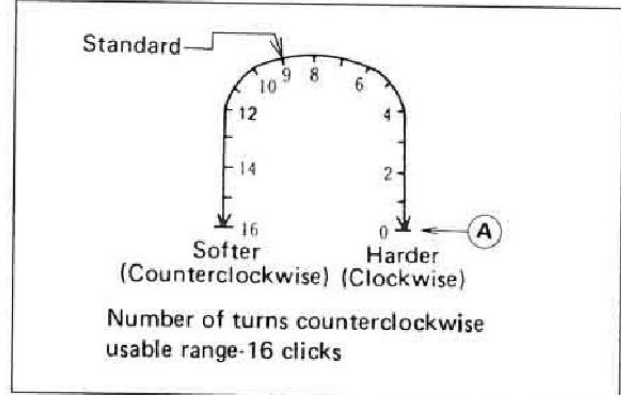

A. Seated position with adjuster turned fully clockwise.

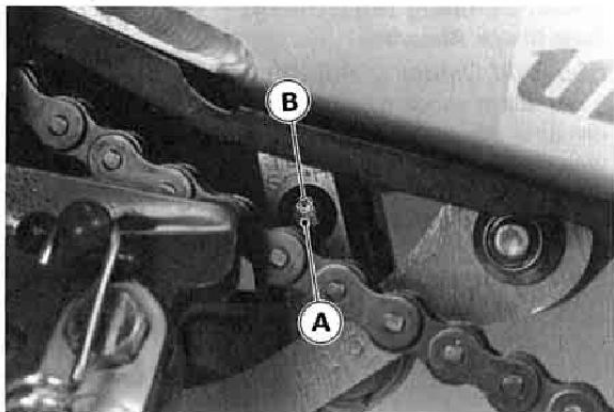

A. Rebound Damping Adjuster

B. Mark

Gas Reservoir

Compression Damping Adjustment

To adjust compression damping, turn the compression damping adjuster on the gas reservoir with the blade of a screwdriver until you feel a click.

If the damper setting feels too soft or too stiff, adjust it in accordance with the following table.

Compression Damping Adjustment

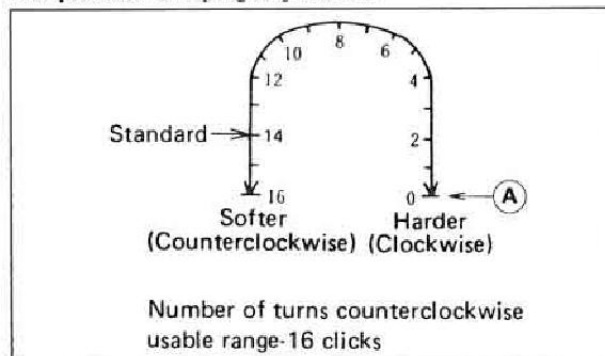

A. Seated position with adjuster turned fully clockwise.

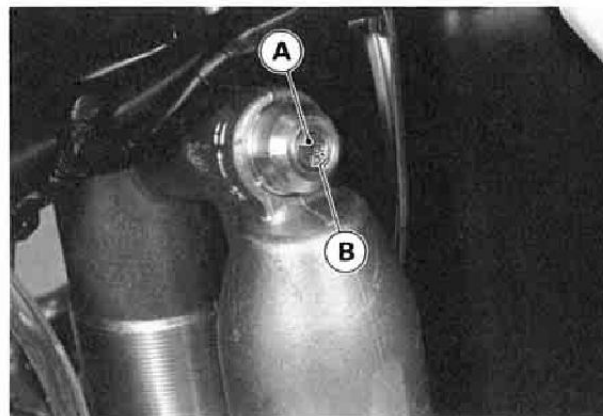

A. Compression Damping Adjuster

B. Mark

Spring Preload Adjustment:

- Remove the right side cover.
- Remove the muffler.
- Remove the clamp from the exhaust pipe rear end.
- Unscrew the exhaust pipe mounting nuts and remove the exhaust pipe.

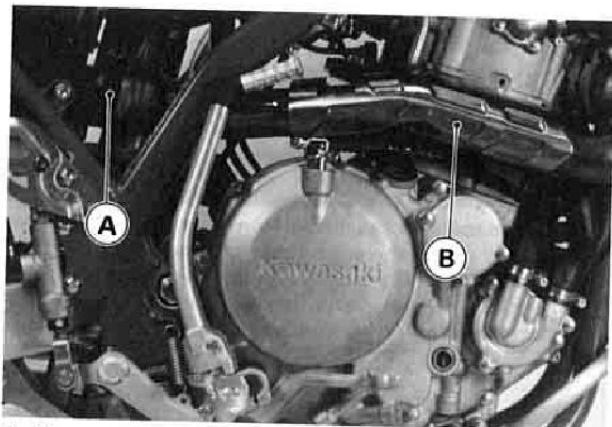

A. Clamp

B. Exhaust Pipe

- Place a jack (special tool) under the frame so that the rear wheel is raised off the ground.
- Using the hook wrenches (special tools), loosen the locknut and turn the adjusting nut as required. Turning the adjusting nut down makes the spring preload stronger.

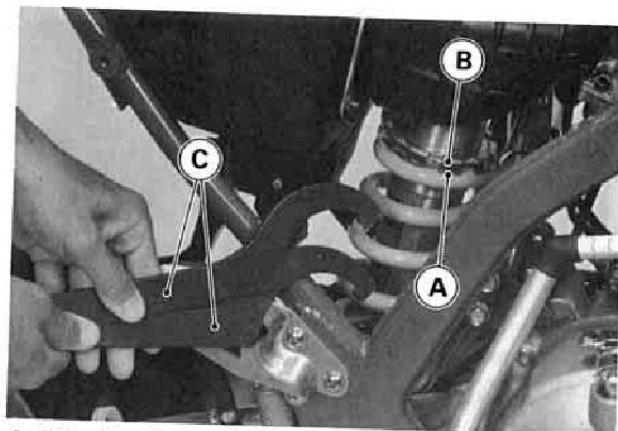

A. Adjusting Nut

B. Locknut

C. Hook Wrenches: 57001-1101

- Standard spring preload is 1,052 N (107.3 kg, 237 lb). The adjusting nut changes the preload 109 N (11.1 kg, 24.5 lb) turn.
- The standard adjusting nut position from the center of the upper mounting hole is 117.5 mm (4.63 in). The adjustable range is 106 – 126 mm (4.17 – 4.96 in).

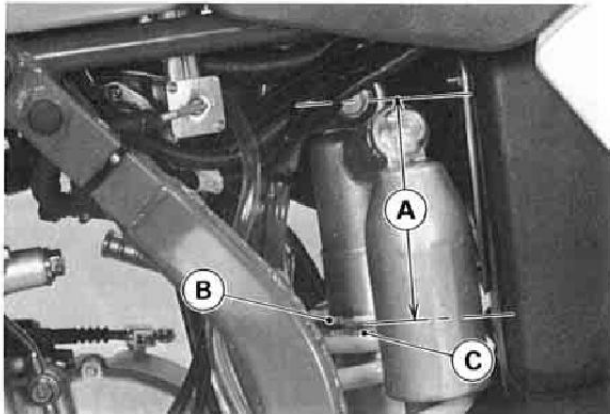

A. Adjusting Nut Position. C. Adjusting Nut
B. Locknut

- Tighten the locknut securely.
- After adjusting, move the spring up and down to make sure that the spring is seated.
- Install the parts removed.

Rear Shock Absorber Spring Replacement:

In addition to the standard spring, hard and soft springs are available. If the standard spring is improper for your purpose, select a proper one according to the rider's weight or course conditions.

- ★ Using the harder spring: The spring rate is higher; the spring is stiffer and rebounds move quickly.
- ★ Using the softer spring: The spring rate is lower; the spring is softer and rebounds more slowly.

⚠ WARNING

Improper removal by spring from rear shock absorber body may cause the spring and/or associated parts to be ejected at high velocity. Always wear eye and face protection. Removal and installation of spring should be performed by an authorized Kawasaki dealer.

Wheels

Tires:

Tire pressure affects traction, handling, and tire life. Adjust the tire pressure to suit track conditions and rider preference, but do not stray too far from the recommended pressure.

NOTE

- Tire pressure should be checked when the tires are cold before your ride.

Track Condition	Tire Pressure
○ When the track is wet, muddy, sandy or slippery, reduce the tire pressure to increase the tire tread surface on the ground.	80 kPa (0.8 kg/cm ² , 11 psi)
	↕
○ When the track is pebbly or hard, increase the tire pressure to prevent damage or punctures, though the tires will skid more easily.	100 kPa (1.0 kg/cm ² , 14 psi)

Spokes and Rim:

The spokes on both wheels must all be tightened securely and evenly and not be allowed to loosen. Unevenly tightened or loose spokes will cause the rim to warp, hasten nipple and overall spoke fatigue, and may result in spoke breakage.

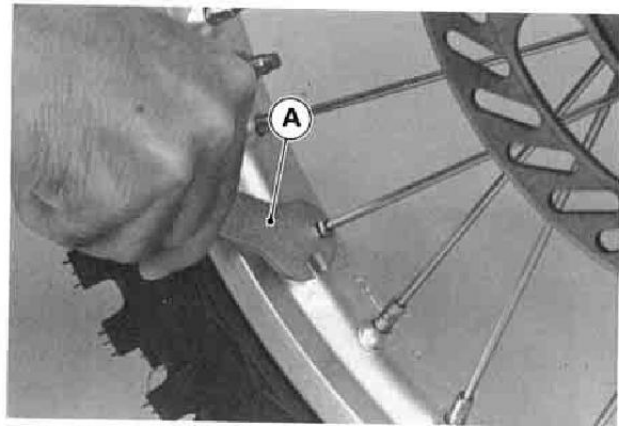

A. Spoke and Spark Plug Wrench

Bead Protector:

There is a bead protector on the front and rear wheels. The bead protector prevents the tire and tube from slipping on the rim and damaging the valve stem. Valve stem damage may cause the tube to leak, necessitating tube replacement. In order that the tire and tube remain fixed in position on the rim, inspect the bead protector before riding and tighten it if necessary. Tighten the valve stem nut finger tight only.

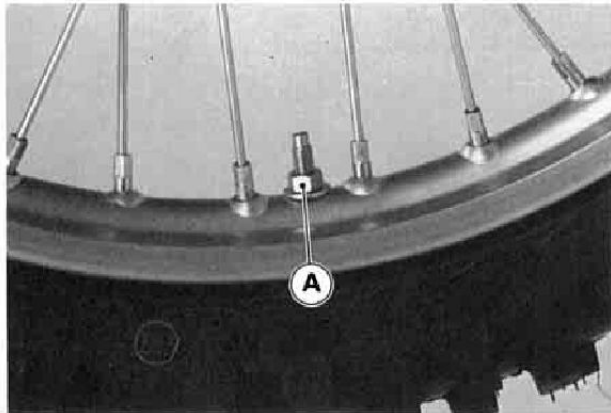

A. Bead Protector Nut

Rim Runout:

Set a dial gauge to the side of the rim, and rotate the wheel to measure axial runout. The difference between the highest and lowest dial readings is the amount of runout.

Set the dial gauge to the inner circumference of the rim and rotate the wheel to measure radial runout. The difference between the highest and lowest dial readings is the amount of runout.

A certain amount of rim warp (runout) can be corrected by recentering the rim, that is, loosening some spokes and tightening others to change the position of different parts of the rim. If the rim is badly bent, however, it should be replaced.

NOTE

○ Weld area of the rim may show excessive runout. Disregard this when measuring runout.

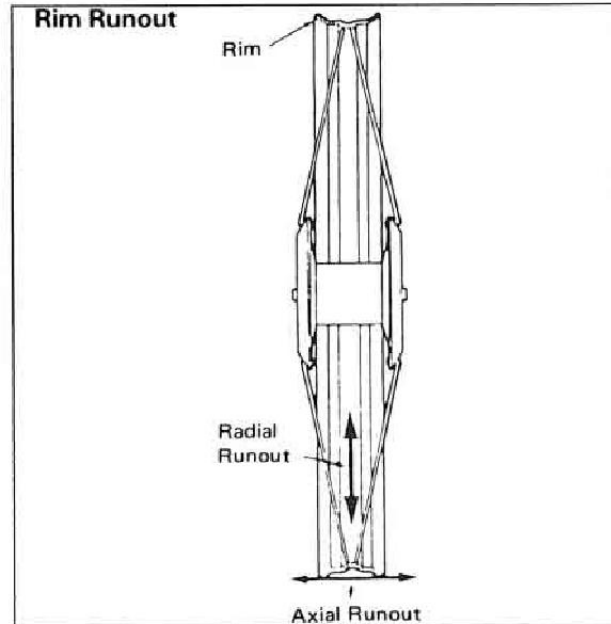

Rim Runout

	Service Limit
Axial	2.0 mm (0.08 in)
Radial	

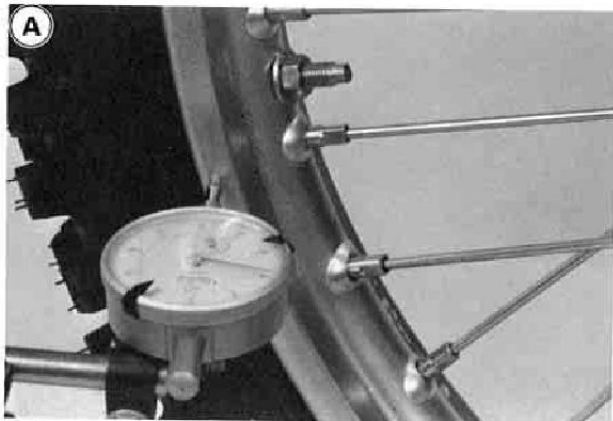

A. Axial Runout

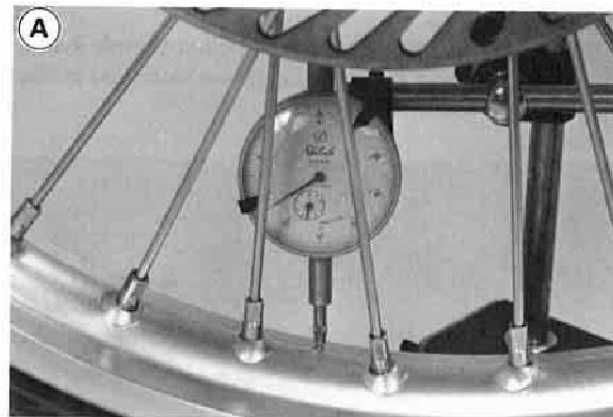

A. Radial Runout

Headlight

Adjust the headlight so that it points slightly below horizontal. Turning the adjusting screw clockwise makes the headlight beam point upward.

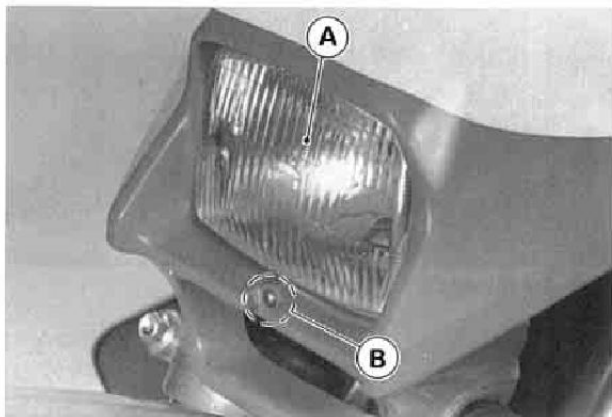

A. Headlight

B. Adjusting Screw

CAUTION

When handling the quartz-halogen bulbs, never touch the glass portion with bare hands. Always use a clean cloth. Oil contamination from hands or dirty rags can reduce bulb life or cause the bulb to explode.

Bolt and Nut Tightening

Every day before riding, check without fail the tightness of the bolts and nuts described here. Also, check to see whether or not each cotter pin is in place and in good condition.

1. Front Fork Clamp Bolts
2. Handlebar Clamp Bolts
3. Clutch Lever Mounting Bolt
4. Spark Plug
5. Rear Shock Absorber Bolts
6. Air Cleaner Case Bolts
7. Seat Mounting Bolts
8. Spokes
9. Brake Hose Holder Mounting Bolt
10. Fork Protector Mounting Bolts
11. Caliper Mounting Bolts
12. Fork Protector Guide Mounting Bolts
13. Front Fender Mounting Bolts
14. Radiator Mounting Bolts
15. Engine Mounting Bolts and Nuts
16. Shift Pedal Bolt
17. Chain Guide Bolts
18. Bead Protector Nut

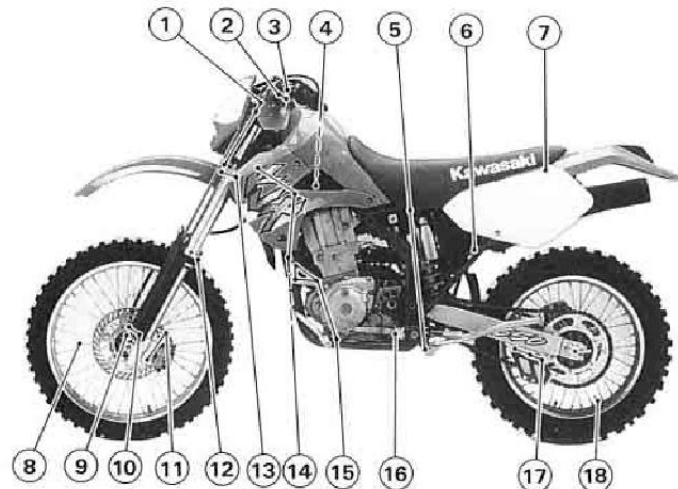

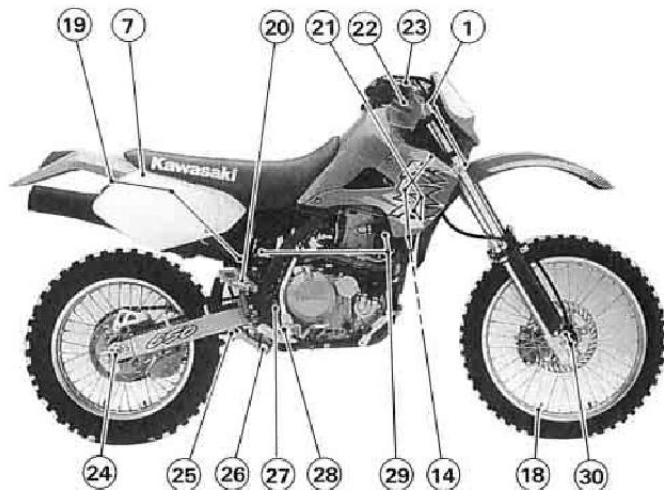

- 19. Muffler Mounting Bolts
- 20. Rear Brake Reservoir Mounting Bolt
- 21. Engine Bracket Bolts
- 22. Steering Stem Head Nut
- 23. Brake Lever Mounting Bolt
- 24. Rear Axle Nut
- 25. Tie Rod Mounting Bolt
- 26. Rocker Arm Mounting Bolt
- 27. Pivot Shaft Nut
- 28. Kick Pedal Bolt
- 29. Exhaust Pipe Mounting Bolt and Nut
- 30. Front Axle Clamp Nuts

Torque Table

Tighten all bolts and nuts to the proper torque using an accurate torque wrench. A bolt or nut if insufficiently tightened may become damaged or fall out, possibly resulting in damage to the motorcycle and injury to the rider. A bolt or nut which is over-tightened may become damaged or break and then fall out.

Part Name		N-m	kg-m	ft-lb	
ENGINE	Engine Drain Plug	29	3.0	22	
	Magneto Flywheel Cover Drain Plug	25	2.5	18	
	Kick Pedal Bolt	17	1.7	12	
	Shift Pedal Bolt	10	1.0	87 (in-lb)	
	Spark Plug	14	1.4	10	
	Water Pump Cover Drain Plug	8.8	0.9	78 (in-lb)	
CHASSIS	Caliper Mounting Bolts	25	2.5	18	
	Disc Plate Mounting Bolts:	Front	9.8	1.0	87 (in-lb)
		Rear	23	2.3	17
	Engine Bracket Nut:	(M8)	29	3.0	22
		(M10)	44	4.5	33
	Engine Mounting Bolts	44	4.5	33	
	Front Axle	88	9.0	65	
	Front Axle Clamp Nut	10	1.0	87 (in-lb)	
	Front Brake Hose Holder Mounting Bolts	10	1.0	87 (in-lb)	
	Front Fork Clamp Nut:	Upper	20	2.0	14.5
		Lower	25	2.5	18
	Front Fork Protector Guide Mounting Bolts	10	1.0	87 (in-lb)	
	Front Fork Protector Mounting Bolts	10	1.0	87 (in-lb)	
	Front Fork Top Bolts	29	3.0	22	
	Handlebar Clamp Bolts	25	2.5	18	
	Pivot Shaft Nut	88	9.0	65	
Rear Axle Nut	98	10.0	72		

	Part Name	N-m	kg-m	ft-lb
CHASSIS	Rear Shock Absorber Nuts	39	4.0	29
	Rear Sprocket Nuts	29	3.0	22
	Spokes	1.5	0.15	13 (in-lb)
	Steering Stem Head Nut	44	4.5	33
	Steering Stem Locknut	4	0.4	35 (in-lb)
	Uni-trak Rocker Arm Bolt	81	8.3	60
	Uni-trak Tie Rod Bolts	81	8.3	60

Cleaning

1) Preparation for washing

Before washing, precautions must be taken to keep water off the following places:

Rear opening of the muffler Cover with a plastic bag secured with rubber bands.

Clutch and brake levers, hand grips, light switch, engine stop button..... Cover with plastic bags.

Air cleaner intake..... Close up the opening with tape, or stuff in rags.

2) Where to be careful

Avoid spraying water with any great force near the following places:

Disc brake master cylinders and calipers

Under the fuel tank If water gets into the ignition coil or into the spark plug cap, the spark will jump through the water and be grounded out. When this happens, the motorcycle will not start and the affected parts must be wiped dry.

Front and rear wheel hubs

Steering pivots (Steering stem head pipe)

Uni-trak system pivots

Swingarm pivot

3) After washing

- Remove the plastic bags, and clean the air cleaner intake.
- Lubricate the points listed in the Lubrication Section.
- Start the engine and run it for 5 minutes.
- Test the brakes before riding the motorcycle.

▲WARNING

Never wax or lubricate the brake disc. Loss of braking and an accident could result. Clean the disc with an oil-less solvent such as trichloroethylene or acetone. Observe the solvent manufacturer's warning.

Lubrication

Lubricate the points shown here, with either motor oil or regular grease, in accordance with the Periodic Maintenance Chart or whenever the vehicle has been operated under wet or rainy conditions, and especially after using a high pressure spray washer. Before lubricating each part, clean off any rusty spots with rust remover and wipe off any grease, oil, dirt, or grime.

General Lubrication

Apply motor oil to the following pivots:

- Side Stand

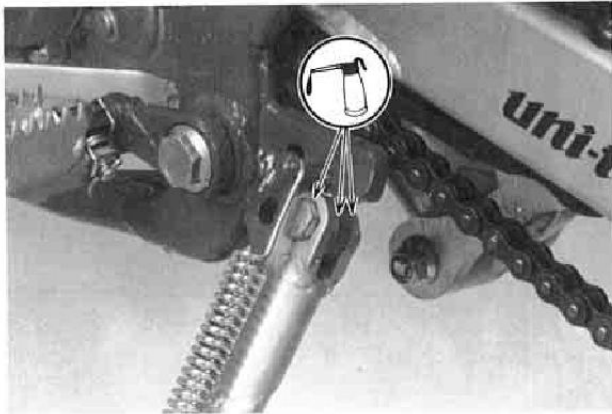

- Clutch Lever
- Front Brake Lever

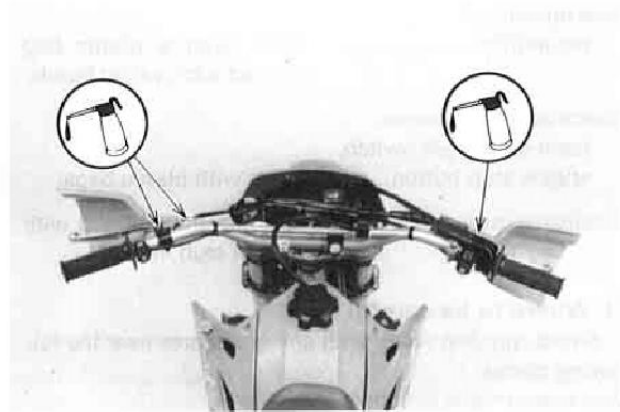

- Rear Brake Pedal
- Rear Brake Rod Joints
- Kick Pedal

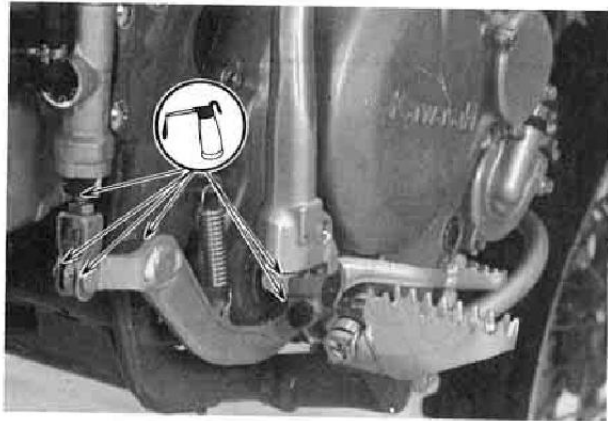

- Shift Pedal

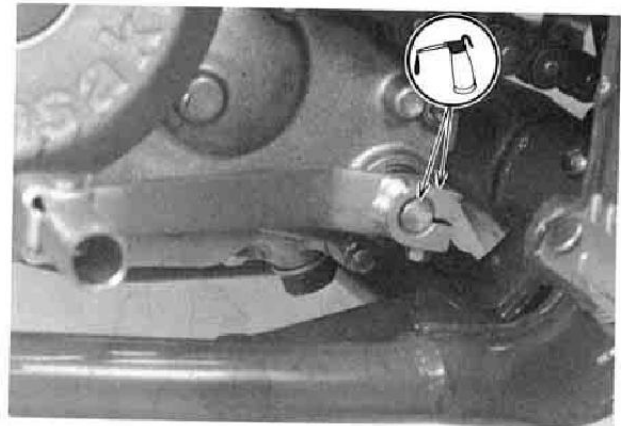

Use an aerosol cable lubricant with a pressure
luber on all cables:

- Clutch Inner Cable
- Throttle Inner Cable

Cable Lubrication

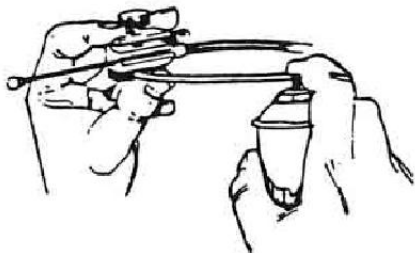

Apply grease to the following points:

- Clutch Inner Cable Upper End
- Throttle Inner Cable Upper End
- Meter Cable Lower End

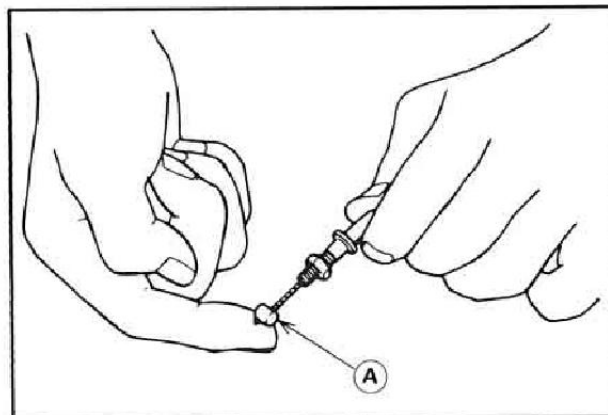

A. Grease.

Drive Chain Lubrication

Lubrication is also necessary after riding through rain or on wet tracks, or any time that the chain appears dry. A heavy oil such as SAE 90 is preferred to a lighter oil because it will stay on the chain longer and provide better lubrication.

- Apply oil to the side of the rollers so that it will penetrate to the rollers and bushings. Apply oil to the O-rings so that the O-rings will be coated with oil. Wipe off any excess oil.

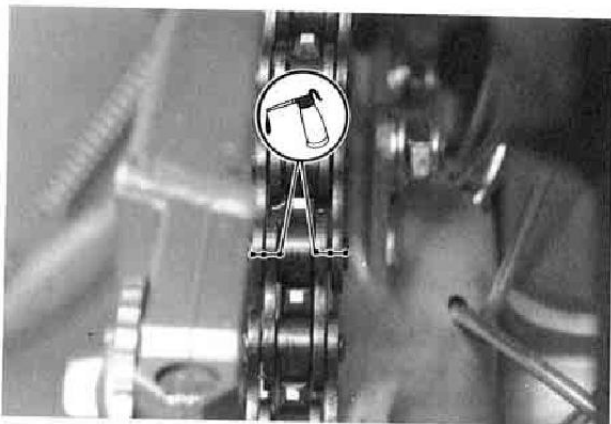

- If the chain is especially dirty, clean it using diesel oil or kerosine and then apply oil as mentioned above.

Air cleaner element clogged
Intake manifold loose
Tank cap air vent obstructed

Compression low

Spark plug loose
Cylinder, piston worn
Piston ring worn, weak, broken, or sticking
Piston ring groove and ring clearance excessive
Cylinder head not sufficiently tightened down
No valve clearance
Cylinder head warped
Cylinder head gasket damaged
Valve spring broken or weak
Valve not seating properly (valve bent, worn, or carbon accumulation on the seating surface)

Other

Ignition timing incorrect
Engine oil viscosity too high

Poor Running or No Power at High Speed:

Mixture too rich or too lean

Air cleaner element clogged
Air cleaner duct loose
Pilot screw maladjusted
Pilot jet, or air passage clogged
Starter plunger stuck open
Tank cap air vent obstructed
Fuel level too high or too low

Compression low

Spark plug loose
Cylinder, piston worn
Piston ring worn, weak, broken, or sticking
Piston ring groove and ring clearance excessive

Cylinder head not sufficiently tightened down
Cylinder head warped
Cylinder head gasket damaged
No valve clearance
Valve spring broken or weak
Valve not seating properly (valve bent, worn, or carbon accumulation on seating surface)

Misfiring

Spark plug worn
Spark plug cap poorly connected or shorted
Ignition coil faulty
High tension lead damage

Knocking

Ignition timing advanced
Fuel poor quality
Carbon built up in combustion chamber

Other

Ignition timing incorrect
Brakes dragging
Overheating
Clutch slipping
Throttle valve does not fully open
Engine oil quantity excessive
Engine oil viscosity too high

Overheating:

- Ignition timing retarded
- Carbon built up in combustion chamber
- Brakes dragging
- Clutch slipping
- Intake manifold loose or damaged
- Main jet clogged
- Fuel level too low
- Coolant level too low
- Coolant deteriorated
- Radiator cap faulty

Clutch Not Operating Smoothly:**Clutch slipping**

- No clutch lever play
- Friction plates worn
- Clutch springs weak
- Clutch release mechanism trouble
- Clutch inner cable not sliding smoothly

Clutch doesn't disengage properly

- Clutch lever play excessive
- Clutch plates warped or damaged
- Clutch springs not evenly tightened
- Engine oil deteriorated or of too high a viscosity
- Clutch release mechanism trouble
- Clutch inner cable not sliding smoothly

Shift Operation Not Smooth:**Doesn't go into gear or shift pedal doesn't return**

- Clutch not disengaging
- Shift return spring weak or broken
- Shift lever spring broken
- Shift lever broken
- Shift fork bent or seized
- Shift drum damaged

Jumps out of gear

- Shift fork worn
- Drive shaft, output shaft, or gear splines worn
- Gear groove worn
- Shift drum groove worn
- Shift fork guide pin worn

Poor Handling or Stability:**Handlebar hard to turn**

- Steering stem nut too tight
- Tire pressure too low
- Steering stem lubrication insufficient

Handlebar vibrates or shakes

- Swingarm bent
- Front fork bent
- Frame bent
- Wheel alignment incorrect
- Pivot shaft warped
- Right/left front fork oil level uneven

Shock absorption too stiff

- Front fork oil quantity excessive
- Front fork oil viscosity too high
- Front fork air pressure too high
- Tire air pressure too high

Shock absorption too soft

- Oil quantity insufficient
- Oil viscosity too low
- Fork spring wear
- Suspension oil leak

Brakes Don't Hold:

- Air in the brake line
- Pad or disc worn
- Brake fluid leak
- Disc warped
- Contaminated pads
- Brake fluid deteriorated
- Primary cup faulty
- Master cylinder scratched inside
- Brake maladjustment (lever play excessive)
- Brakes overheated
- Water in brakes

MEMO



KLX650-D1



KAWASAKI HEAVY INDUSTRIES, LTD.
Consumer Products & Machinery Group

Part No. 99923-1436-02