

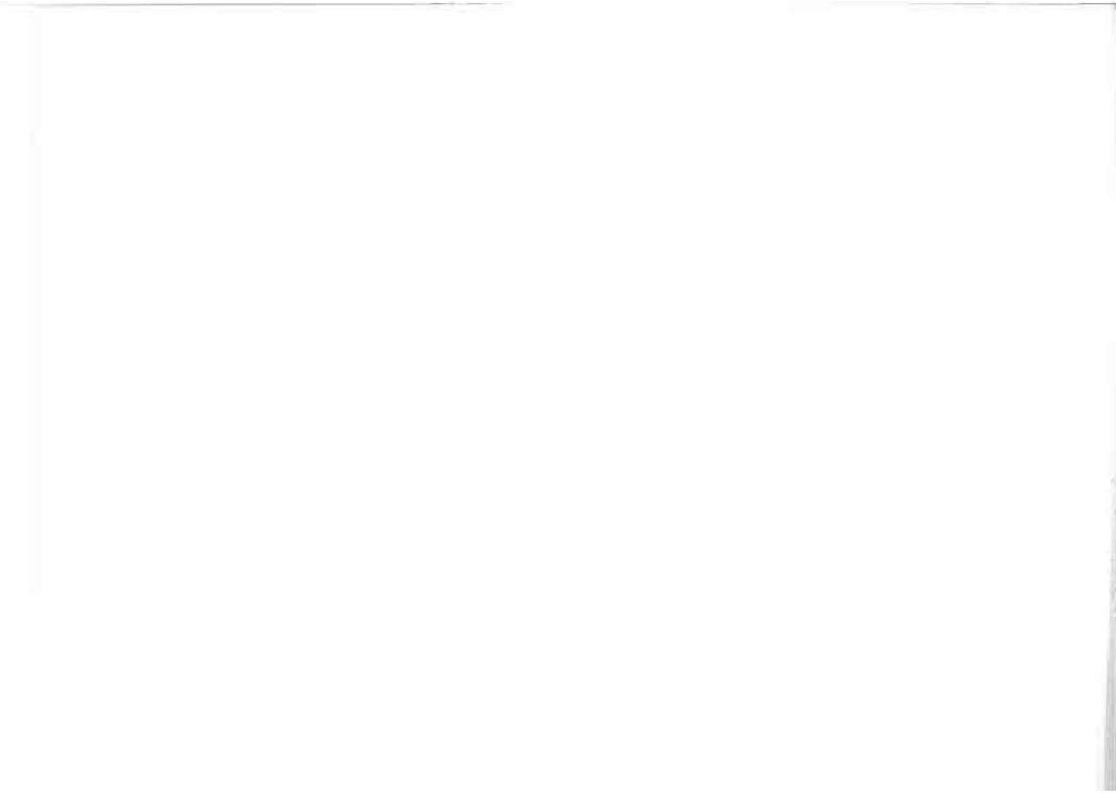

保存版

KLX650

Motorcycle Owner's Manual



Whenever you see the symbols shown below, heed their instructions! Always follow safe operating and maintenance practices.

⚠ WARNING

This warning symbol identifies special instructions or procedures which, if not correctly followed, could result in personal injury, or loss of life.

CAUTION

This caution symbol identifies special instructions or procedures which, if not strictly observed, could result in damage to or destruction of equipment.

NOTE

○ *This note symbol indicates points of particular interest for more efficient and convenient operation.*

NOTICE

THIS PRODUCT HAS BEEN MANUFACTURED FOR USE IN A REASONABLE AND PRUDENT MANNER BY A QUALIFIED OPERATOR AND AS A VEHICLE ONLY.

(Australian model only)

TAMPERING WITH NOISE CONTROL SYSTEM

Owners are warned that the law may prohibit:

- (a) The removal or rendering inoperative by any person other than for purposes of maintenance, repair or replacement, of any device or element of design incorporated into any new vehicle for the purpose of noise control prior to its sale or delivery to the ultimate purchaser or while it is in use; and**
- (b) the use of the vehicle after such device or element of design has been removed or rendered inoperative by any person.**

FOREWORD

We wish to thank you for choosing this fine Kawasaki Motorcycle. Your new motorcycle is the product of Kawasaki's advanced engineering, exhaustive testing, and continuous striving for superior reliability, safety, and performance.

Read this Owner's Manual before riding so you will be thoroughly familiar with the proper operation of your motorcycle's controls, its features, capabilities and limitations. This manual offers many safe riding tips, but its purpose is not to provide instruction in all the techniques and skills required to ride a motorcycle safely. Kawasaki strongly recommends that all operators of this vehicle enroll in a motorcycle rider training program to attain awareness of the mental and physical requirements necessary for safe motorcycle operation.

To ensure a long, trouble-free life for your motorcycle, give it the proper care and maintenance described in this manual. For those who would like more detailed information on their Kawasaki Motorcycle, a Service Manual is available for purchase from any Kawasaki dealer. The Service Manual contains detailed disassembly and maintenance information.

Due to improvements in design and performance during production, in some cases there may be minor discrepancies between the actual vehicle and the illustrations and text in this manual.

KAWASAKI HEAVY INDUSTRIES, LTD.

CONSUMER PRODUCTS GROUP

Safe Operation	39	Battery.....	82
Daily Safety Checks.....	39	Headlight Beam.....	84
Additional Considerations for		Fuses.....	87
Off Road Operation.....	41	Fuel System.....	88
Maintenance and Adjustment	42	Cleaning.....	90
Periodic Maintenance Chart.....	43	Storage	92
Engine Oil.....	46	Wiring Diagram	Inside back cover
Cooling System.....	50		
Spark Plug.....	53		
Valve Clearance.....	55		
Air Cleaner.....	56		
Throttle Grip.....	60		
Carburetor.....	63		
Clutch.....	64		
Drive Chain.....	66		
Brakes.....	71		
Brake Light Switches.....	77		
Front Fork.....	78		
Rear Shock Absorber.....	79		
Wheels.....	80		

Ignition Timing

5° BTDC @1,300 r/min (rpm) ~

31° BTDC @3,000 r/min (rpm)

Spark Plug

NGK DPR8EA-9 or ND X24EPR-U9

Lubrication System

Forced lubrication (wet sump)

Engine Oil

SE, SF or SG class SAE 10W40, 10W50,
20W40, or 20W50

Engine Oil Capacity

2.1 L (2.2 US qt)

Coolant Capacity

1.9 L (2.0 US qt)

TRANSMISSION

Transmission Type

5-speed, constant mesh, return shift

Clutch Type

Wet, multi disc

Driving System

Chain drive

Primary Reduction Ratio

2.272 (75/33)

Final Reduction Ratio

2.866 (43/15)

Overall Drive Ratio

5.157 (Top gear)

Gear Ratio:

1st

2.266 (34/15)

2nd

1.529 (26/17)

3rd

1.181 (26/22)

4th

0.954 (21/22)

5th

0.791 (19/24)

FRAME

Castor		28.5°
Trail		122 mm (4.80 in.)
Tire Size:	Front	90/90-21 54S
	Rear	130/80-17 65S
Fuel Tank Capacity		12 L (3.2 US gal)

ELECTRICAL EQUIPMENT

Battery	12 V 8 Ah
Headlight	12 V 60/55 W
Tail/Brake Light	12 V 5/21 W
Turn Signal Light	12 V 21 W

<I> : Italian model

<G> : Greek model

<N> : Norwegian model

<Sd> : Swedish model

Specifications subject to change without notice, and may not apply to every country.

10. Front Fork
11. Headlight
12. Turn Signal Light
13. Fuel Tank Cap
14. Fuel Tank
15. Fuel Tap
16. Tool Kit Container
17. Battery
18. Helmet Hook
19. Rear Carrier
20. Brake Disc
21. Brake Caliper
22. Radiator
23. Shift Pedal
24. Side Stand Switch
25. Rear Shock Absorber
26. Side Stand
27. Drive Chain
28. Coolant Reserve Tank

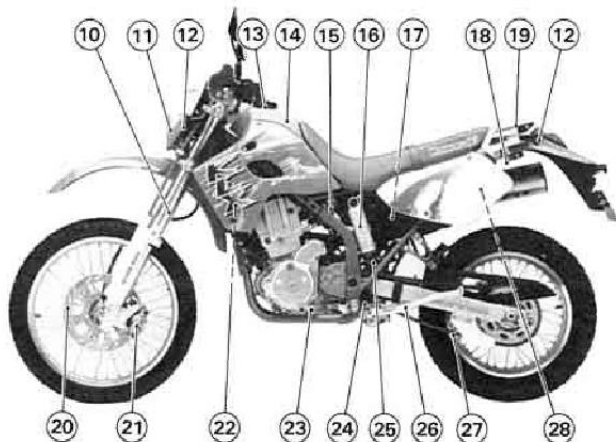

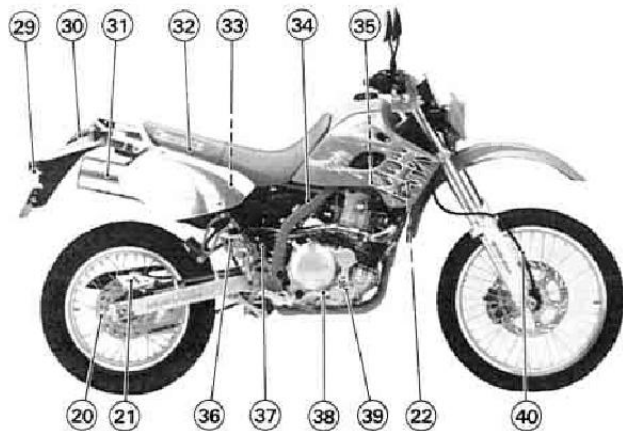

- 29. License Plate Light
- 30. Tail/Brake Light
- 31. Muffler
- 32. Seat
- 33. Air Cleaner Element
- 34. Carburetor
- 35. Spark Plug
- 36. Brake Fluid Reservoir
(Rear)
- 37. Rear Brake Light Switch
- 38. Rear Brake Pedal
- 39. Oil Level Gauge
- 40. Speedometer Cable

Speedometer and Tachometer

The speedometer shows the speed of the vehicle. In the speedometer face are the odometer and trip meter. The odometer shows the total distance that the vehicle has been ridden. The trip meter shows the distance traveled since it was last reset to zero. The trip meter can be reset to zero by turning the reset knob counterclockwise.

The tachometer shows the engine speed in the revolutions per minute (r/min, rpm). On the right side of the tachometer face is a portion called the "red zone." Engine r/min (rpm) in the red zone is above maximum recommended engine speed and is also above the range for good performance.

CAUTION

Engine r/min (rpm) should not be allowed to enter the red zone; operation in the red zone will overstress the engine and may cause serious engine damage.

Indicator Lights

N : When the transmission is in neutral, the neutral indicator light is lit.

 : When the turn signal switch is turned to left or right, the turn signal indicator light flashes on and off.

 : When the headlight is on high beam, the high beam indicator light is lit.

 : The coolant temperature warning light goes on whenever the ignition switch is in the ON position with the engine in neutral, and goes off when the transmission is in any gear. If the coolant temperature rises to 115°C or higher, the light will not go off and will stay on even in any gear. In this case, stop the engine and check the coolant level in the reserve tank after the engine cools down.

Key

This motorcycle has a combination key, which is used for the ignition switch/steering lock, fuel tank cap, tool kit container and helmet hook.

Blank keys are available at your Kawasaki dealers. Ask your Dealer to make any additional spare keys you may need, using your original key as a master.

Ignition Switch/Steering Lock

This is a four-position, key-operated switch. The key can be removed from the switch when it is in the OFF, LOCK, or P(PARK) position.

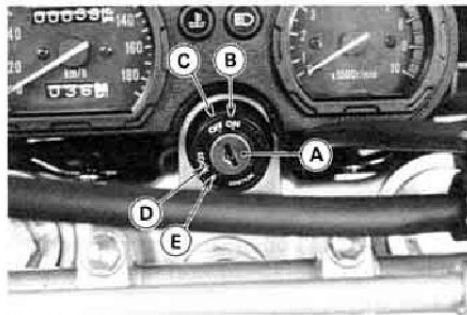

- A. Ignition Switch/Steering Lock
- B. ON position
- C. OFF position
- D. LOCK position
- E. P (Park) position

ON	Engine on. All electrical equipment can be used.
OFF	Engine off. All electrical circuits off.
LOCK	Steering locked. Engine off. All electrical circuits off.
P(Park)	Steering locked. Engine off. Taillight and city light (except Australian model) on. All other electrical circuits cut off.

NOTE

○Australian model only: The taillight is on whenever the ignition switch is in the ON position. The headlight goes on when the starter button is released after starting the engine. To avoid battery discharge, always start the engine immediately after turning the ignition switch to ON.

○If you leave the PARK position on for a long time (one hour), the battery may become totally discharged.

To lock the steering:

1. Turn the handlebar fully to the left.
2. With the ignition switch key in the OFF position, push down and release the key.
3. Turn the key to LOCK or P(Park) position.
4. Pull the key out.

Right Handlebar Switches Engine Stop Switch

In addition to the ignition switch, the engine stop switch must be in the RUN position for the motorcycle to operate.

The engine stop switch is for emergency use. If some emergency requires stopping the engine, push the engine stop switch to the OFF position.

NOTE

○ *Although the engine stop switch stops the engine, it does not turn off all the electrical circuits. Ordinarily, the ignition switch should be used to stop the engine.*

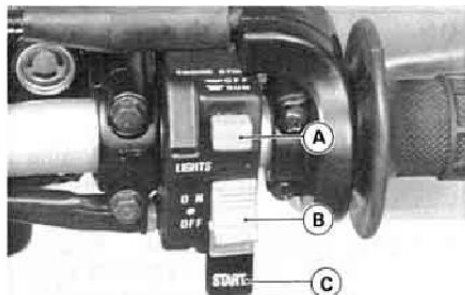

- A. Engine Stop Switch**
- B. Headlight Switch**
- C. Starter Button**

Starter Button

The starter button operates the electric starter when pushed with the clutch lever pulled in or the transmission in neutral.

Refer to the Starting the Engine section of the "How to Ride the Motorcycle" chapter for starting instructions.

Headlight Switch (except Australian model)

OFF	The headlight is off with the switch in the OFF position.
○	The city, tail, license plate, and meter lights come on if the switch is pushed to the ○ position with the ignition switch in the ON position.
ON	The head, city, tail, license plate, and meter lights come on if the switch is pushed upward to the ON position with the ignition switch in the ON position.

Left Handlebar Switches Dimmer Switch

High or low beam can be selected with the dimmer switch. When the headlight is on high beam (HI), the high beam indicator light is lit.

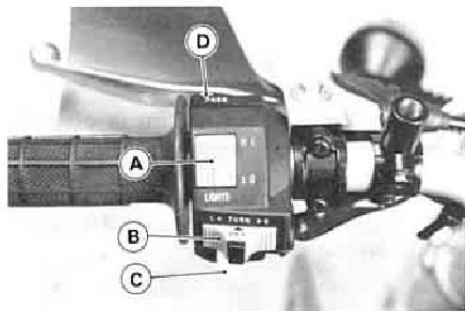

- A. Dimmer Switch
- B. Turn Signal Switch
- C. Horn Button
- D. Passing Button

Turn Signal Switch

When the turn signal switch is turned to L (left) or R (right), the corresponding turn signals flash on and off.

To stop flashing, push the switch in.

Horn Button

When the horn button is pushed, the horn sounds.

Passing Button

When the passing button is pushed, the headlight high beam (passing beam) comes on to signal the driver of the vehicle ahead that you are about to pass him. The passing light shuts off as soon as the switch is released.

Fuel Tank Cap

To open the fuel tank cap, slide the key hole cover open, insert the ignition switch key into the lock, turn the key to the OPEN position, and turn the cap counterclockwise.

To close the cap, turn the cap clockwise with the key inserted. The key can be removed by turning it counterclockwise to the original position.

NOTE

○ *The tank cap cannot be closed without the key inserted, and the key cannot be removed unless the cap is locked properly.*

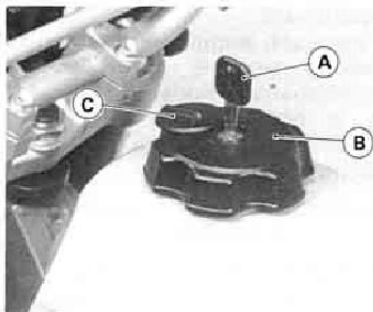

- A. Ignition Switch Key
- B. Fuel Tank Cap
- C. Key Hole Cover

Fuel Tank

Avoid filling the tank in the rain or where heavy dust is blowing so that the fuel does not get contaminated.

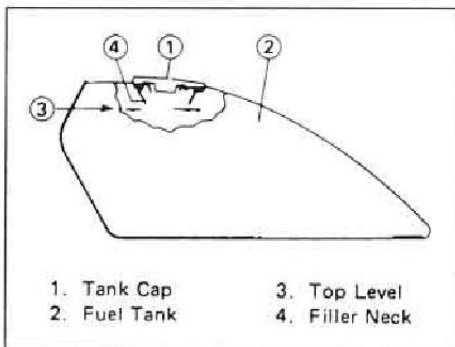

- 1. Tank Cap
- 2. Fuel Tank
- 3. Top Level
- 4. Filler Neck

▲WARNING

Gasoline is extremely flammable and can be explosive under certain conditions. Turn the Ignition switch OFF. Do not smoke. Make sure the area is well ventilated and free from any source of flame or sparks; this includes any appliance with a pilot light. Never fill the tank so the fuel level rises into the filler neck. If the tank is overfilled, heat may cause the fuel to expand and overflow through the vents in the tank cap. After refueling, make sure the tank cap is closed securely. If gasoline is spilled on the fuel tank, wipe it off immediately.

Fuel Requirement:

Your Kawasaki engine is designed to use unleaded gasoline. However, except for Australian models, if suitable gasoline is not available then PREMIUM, SUPER, or FOUR-STAR gasolines may be used.

CAUTION

Use of leaded gasoline is illegal in some countries, states or territories. Check local regulations before using leaded gasoline.

Octane Rating

The octane rating of a gasoline is a measure of its resistance to detonation or "knocking." The term commonly used to describe a gasoline's octane rating is the Research Octane Number (RON). Always use a gasoline with an octane rating equal to, or higher than, Research Octane Number (RON) 91.

NOTE

○ If "knocking" or "pinging" occurs, use a different brand of gasoline or higher octane rating.

Fuel Tap

The fuel tap has three positions: OFF, ON, and RES (reserve). For normal operation turn the tap to the ON position. If the fuel runs out with the tap in the ON position, the last 2.0 L (0.53 US gal) of fuel can be used by turning the tap to the RES position.

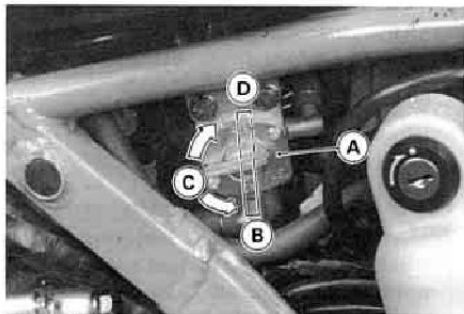

A. Fuel Tap

B. ON position

C. OFF position

D. RES position

With the fuel tap in the ON or RES position fuel flows to carburetor only

when the engine is started or is running, and fuel supply is shut off when the engine is stopped.

Turn the fuel tap to the OFF position when the fuel tank is removed for maintenance and adjustments or the motorcycle is stored for a long time.

NOTE

- *Since riding distance is limited when on RES, refuel at the earliest opportunity.*
- *Make certain that the fuel tap is turned to ON (Not RES) after filling up the fuel tank.*

▲WARNING

**Practice operating the fuel tap with the motorcycle stopped. To prevent an accident you should be able to operate the fuel tap while riding without taking your eyes off the road.
Be careful not to touch the hot engine while operating the fuel tap.**

Stand

The motorcycle is equipped with the side stand.

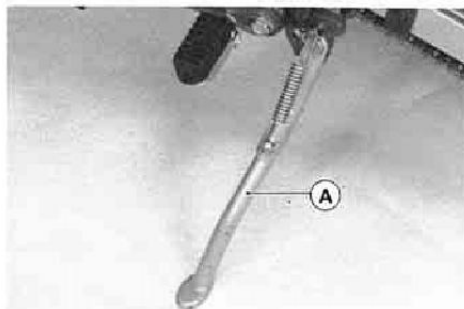

A. Side Stand

NOTE

- *When using the side stand, turn the handlebar to the left.*

Whenever the side stand is used, make it a practice to kick the stand fully up before sitting on the motorcycle.

NOTE

○ *The motorcycle is equipped with a side stand switch. This switch is designed so that the engine stops if the clutch is engaged with the transmission in gear when the side stand has been left down.*

Tool Kit Container

The tool kit container is located forward the left side cover. Use this container to keep the tool kit that should be kept with the motorcycle.

The tool kit container can be unlocked by inserting the ignition switch key into the lock, and turning the key to the right.



A. Tool Kit Container

B. Tool Kit

Tool Kit

The minor adjustments and replacement of parts explained in this manual can be performed with the tools in the kit.

Helmet Hook

Helmet can be secured to the motorcycle using the helmet hook located under the seat.

The helmet hook can be unlocked by inserting the ignition switch key into the lock, and turning the key to the right.

WARNING

Do not ride the motorcycle with a helmet attached to the hook. The helmet could cause an accident by distracting the operator or interfering with normal vehicle operation.

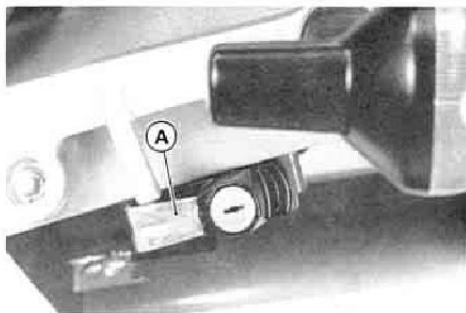

A. Helmet Hook

Rear Carrier

The motorcycle is equipped with a carrier on the rear.

Rear Carrier	10 kg
Maximum Load Capacity	(22 lb)



A. Rear Carrier

▲WARNING

Never exceed the rear carrier load limit of 10 kg (22 lb). It is designed for light items, and overloading can affect handling due to changes in weight distribution and aerodynamic force.

Do not exceed the vehicle speed of 130 km/h (80 mph) when carrying a load of more than 5 kg (11 lb) on the carrier.

Overloading and failure to adjust speed to compensate for addition of cargo may result in loss of control and an accident. speed must also be adjusted to suit various road and weather conditions.

»»»»»»»»»»»»»»»»»» HOW TO RIDE THE MOTORCYCLE ««««««««««««««««««

Starting the Engine

- Turn the fuel tap to the ON position.

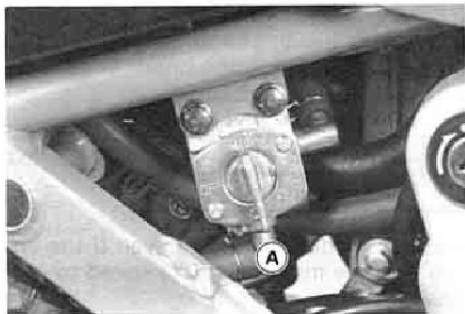

A. ON position

- Check that the engine stop switch is in the RUN position.
- Turn the ignition switch on.
- Make certain the transmission is in neutral or the clutch is disengaged.

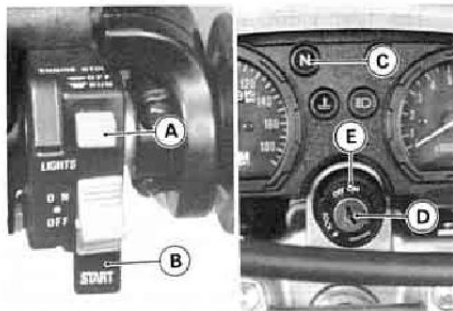

- A. Engine Stop Switch
- B. Starter Button
- C. Neutral Indicator Light
- D. Ignition Switch
- E. ON position

- If the engine is cold, pull up the choke knob all the way.

NOTE

- *When the engine is already warm or on hot days (35°C, 95°F or more), open the throttle part way instead of using the choke, and then start the engine.*



A. Choke Knob

- **Leaving the throttle completely closed, push the starter button with the clutch lever pulled in until the engine starts.**

CAUTION

Do not operate the starter continuously for more than 5 seconds, or the starter will overheat and the battery power will drop temporarily. Wait 15 seconds between each operation of the starter to let it cool and the battery power recover.

NOTE

- *If the engine is flooded, crank the engine over with the throttle fully open until the engine starts.*
- *The motorcycle is equipped with a starter lockout switch. This switch prevents the electric starter from operating when the clutch is engaged and the transmission is not in neutral.*

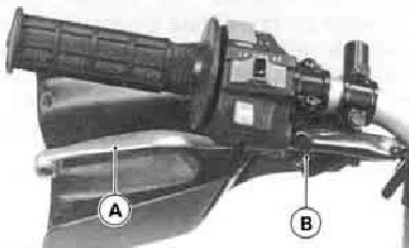

A. Clutch Lever
B. Starter Lockout Switch

- Gradually return the choke toward the off position a little at a time as necessary to keep the engine speed below 2,000 r/min (rpm) during warm-up.
- When the engine is warmed up enough to idle without using the choke, return the choke to the off position.

NOTE

○ If you drive the motorcycle before the engine is warmed up, return the choke to the off position after you have drive the motorcycle for the length of time shown in the table.

CAUTION

Do not let the engine idle longer than five minutes, or engine overheating and damage may occur.

Ambient temperature	choke off after running for
20°C (68°F) ~ 35°C (95°F)	15 seconds
Below 20°C (68°F)	1.5 minutes
Below 5°C (40°F)	2 minutes

Jump Starting

If your motorcycle battery is "run down," it should be removed and charged. If this is not practical, a 12 volt booster battery and jumper cables may be used to start the engine.

⚠WARNING

Battery acid generates hydrogen gas which is flammable and explosive under certain conditions. It is present within a battery at all times, even in a discharged condition. Keep all flames and sparks (cigarettes) away from the battery. Wear eye protection when working with a battery. In the event of battery acid contact with skin, eyes, or clothing, wash the affected areas immediately with water for at least five minutes. Seek medical attention.

Connecting Jumper Cables

- Make sure the ignition switch is turned "OFF."

- Remove the left side cover and battery cover.
- Connect a jumper cable from the positive (+) terminal of the booster battery to the positive (+) terminal of the motorcycle battery.

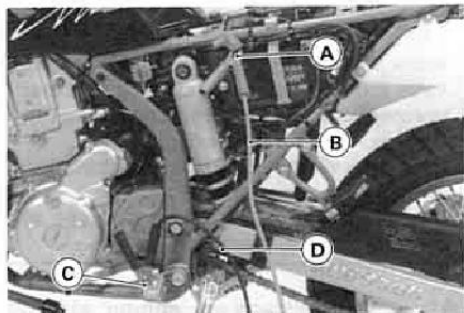

- A. Motorcycle Battery Positive (+) Terminal
- B. To Booster Battery Positive (+) Terminal
- C. Unpainted Metal Surface
- D. To Booster Battery Negative (-) Terminal

- Connect another jumper cable from the negative (-) terminal of the booster battery to your motorcycle

rear brake pedal or other unpainted metal surface. Do not use the negative (-) terminal of the battery.

⚠WARNING

Do not make this last connection at the carburetor or battery. Take care that you do not touch the positive and negative cables together, and do not lean over the battery when making this last connection. Do not jump start a frozen battery. It could explode.

Do not reverse polarity by connecting positive (+) to negative (-), or a battery explosion and serious damage to the electrical system may occur.

- Follow the standard engine starting procedure.

CAUTION

Do not operate the starter continuously for more than 5 seconds or the starter will overheat and the battery power will drop temporarily. Wait 15 seconds between each operation of the starter to let it cool and the battery power recover.

- After the engine starts, disconnect the jumper cables. Disconnect the negative (-) cable from the motorcycle first.

Moving Off

- Check that the side stand is up.
- Pull in the clutch lever.
- Shift into 1st gear.
- Open the throttle a little, and start to let out the clutch lever very slowly.
- As the clutch starts to engage, open the throttle a little more, giving the engine just enough fuel to keep it from stalling.

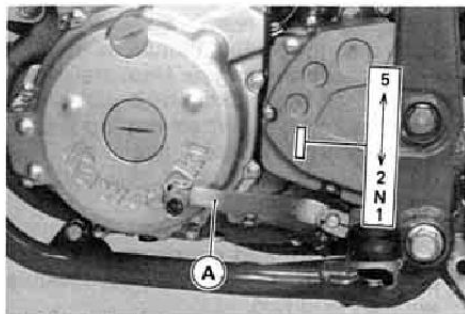

A. Shift Pedal

NOTE

- *The motorcycle is equipped with a side stand switch. This switch is designed so that the engine stops if the clutch is engaged with the transmission in gear when the side stand has been left down.*

Shifting Gears

- Close the throttle while pulling in the clutch lever.
- Shift into the next higher or lower gear.

▲WARNING

When shifting down to a lower gear, do not shift at such a high speed that the engine r/min (rpm) jumps excessively. Not only can this cause engine damage, but the rear wheel may skid and cause an accident. Downshifting should be done below 5,000 r/min (rpm) for each gear.

- Open the throttle part way, while releasing the clutch lever.

Braking

- Close the throttle completely, leaving the clutch engaged (except when shifting gears) so that the engine will help slow down the motorcycle.
- Shift down one gear at a time so that you are in 1st gear when you come to a complete stop.
- When stopping, always apply both brakes at the same time. Normally the front brake should be applied a little more than the rear. Shift down or fully disengage the clutch as necessary to keep the engine from stalling.
- Never lock the brakes, or it will cause the tires to skid. When turning a corner, it is better not to brake at all. Reduce your speed before you get into the corner.
- For emergency braking, disregard downshifting, and concentrate on applying the brakes as hard as possible without skidding.

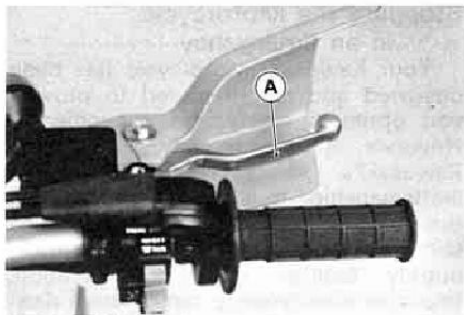

A. Front Brake Lever

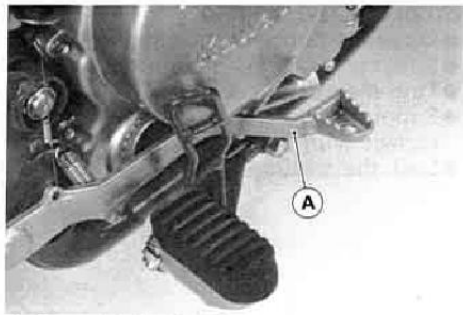

A. Rear Brake Pedal

Stopping the Engine

- Close the throttle completely.
- Shift the transmission into neutral.
- Turn the ignition switch off.
- Support the motorcycle on a firm level surface with the side stand.
- Lock the steering.

Stopping the Motorcycle in an Emergency

Your Kawasaki Motorcycle has been designed and manufactured to provide you optimum safety and convenience. However, in order to fully benefit from Kawasaki's safety engineering and craftsmanship, it is essential that you, the owner and operator, properly maintain your motorcycle and become thoroughly familiar with its operation. Improper maintenance can create a dangerous situation known as throttle failure. Two of the most common causes of throttle failure are:

1. An improperly serviced or clogged air cleaner may allow dirt and dust to enter the carburetor and stick the throttle open.
2. During removal of the air cleaner, dirt is allowed to enter and jam the carburetor.

In an emergency situation such as throttle failure, your vehicle may be stopped by applying the brakes and disengaging the clutch. Once this stop-

ping procedure is initiated, the engine stop switch may be used to stop the engine. If the engine stop switch is used, turn off the ignition switch after stopping the motorcycle.

Parking

- Shift the transmission into neutral and turn the ignition switch OFF.
- Support the motorcycle on a firm level surface with the side stand.

CAUTION

Do not park on a soft or steeply inclined surface or the motorcycle may fall over.

- If parking inside a garage or other structure, be sure it is well ventilated and the motorcycle is not close to any source of flame or sparks; this includes any appliance with a pilot light.

▲WARNING

Gasoline is extremely flammable and can be explosive under certain conditions.

- Lock the steering to help prevent theft.

NOTE

- *When stopping near traffic at night, you can leave the taillight and city light (except Australian model) on for greater visibility by turning the ignition switch to the P (park) position.*
- *Do not leave the switch at P position too long, or the battery will discharge.*

Drive chain	Slack 55 ~ 65 mm (2.2 ~ 2.6 in.).
Nuts, bolts, fasteners	Check that steering and suspension components, axles, and all controls are properly tightened or fastened.
Steering	Action smooth but not loose from lock to lock. No binding of control cables.
Brakes	Brake pad wear: Lining thickness more than 1 mm (0.04 in.) left.
	No brake fluid leakage.
Throttle	Throttle grip play 2 ~ 3 mm (0.08 ~ 0.12 in.).
Clutch	Clutch lever play 10 ~ 20 mm (0.4 ~ 0.8 in.).
	Clutch lever operates smoothly.
Coolant	No coolant leakage.
.....	Coolant level between level lines (when engine is cold).
Radiator cap	Properly installed.
Electrical equipment	All lights and horn work.
Engine stop switch	Stops engine.
Side stand	Returns to its fully up position by spring tension.
	Return spring not weak or not damaged.

Refer to the "Daily Safety Checks" caution label attached to the inside of the left side cover.

Additional Considerations for Off Road Operation

Brakes: The importance of reliable brakes is obvious. Check to see that they are functioning properly.

Steering: Looseness in the steering can cause loss of control. Check to see that the handlebar turns freely but has no play.

Tires: Due to the extra stress to the tires on rough roads, be sure to examine their overall condition, and inflate to the proper pressure.

Drive Chain: When not adjusted properly, the severe stress on rough roads can cause damage to the sprockets and cause the chain to be thrown. Examine the chain slack and alignment, and lubricate if necessary.

Fuel: Have sufficient fuel for the high fuel consumption on rough roads.

Engine Oil: To avoid seizure and resulting loss of control, make certain that the oil level is at the upper level line.

Coolant: To avoid overheating, check that the coolant level is at the upper level line.

Miscellaneous: Check to see that the electrical equipment is functioning properly, all nuts and bolts are tight, and all safety related parts are in good condition.

»»»»»»»»»»»»»»»» MAINTENANCE AND ADJUSTMENT ««««««««««««««««

The maintenance and adjustments outlined in this chapter are easily carried out and must be done in accordance with the Periodic Maintenance Chart to keep the motorcycle in good running condition. **The initial maintenance is vitally important and must not be neglected.**

If you are in doubt as to any adjustment or vehicle operation, please ask your authorized Kawasaki dealer to check the motorcycle.

Please note that Kawasaki cannot assume any responsibility for damage resulting from incorrect maintenance or improper adjustment done by the owner.

Periodic Maintenance Chart

Operation	Frequency	Which ever comes first ↓ Every	*Odometer Reading							See Page
			800 (500)	5,000 (3,000)	10,000 (6,000)	15,000 (9,000)	20,000 (12,000)	25,000 (15,000)	30,000 (18,000)	
Idle speed—check †			•	•	•	•	•	•	•	63
Throttle grip play—check †			•		•		•		•	60
Spark plug—clean and gap †				•	•	•	•	•	•	53
K Valve clearance—check †			•		•		•		•	55
Air cleaner element—clean			•		•		•		•	56
Air cleaner element—replace		5 cleanings					•			56
Fuel system—check †					•		•		•	88
Brake light switch—check †			•	•	•	•	•	•	•	77
Brake pad wear—check †				•	•	•	•	•	•	73
Brake fluid level—check †		month	•	•	•	•	•	•	•	74
K Brake fluid—change		2 years					•			76

Operation	Frequency	*Odometer Reading km (mi)							See Page
	Whichever comes first ↓	800 (500)	5,000 (3,000)	10,000 (6,000)	15,000 (9,000)	20,000 (12,000)	25,000 (15,000)	30,000 (18,000)	
	Every								
Clutch--adjust		•	•	•	•	•	•	•	64
K Steering play--check †		•	•	•	•	•	•	•	—
Drive chain wear--check †			•	•	•	•	•	•	69
K Spoke tightness and rim runout --check †		•	•	•	•	•	•	•	—
Nuts, bolts, fasteners tightness --check †		•		•		•		•	—
Tire wear--check †			•	•	•	•	•	•	81
Engine oil--change	year	•		•		•		•	47
Oil filter--replace		•		•		•		•	47
General lubrication--perform			•	•	•	•	•	•	—
K Front fork oil--change								•	—
K Swing arm pivot, uni--trak linkage --lubricate				•		•		•	—
K Coolant--change	2 years							•	52

Operation	Frequency	*Odometer Reading							See Page
	Whichever comes first ↓	800 (500)	5,000 (3,000)	10,000 (6,000)	15,000 (9,000)	20,000 (12,000)	25,000 (15,000)	30,000 (18,000)	
Radiator hoses, connections -check †	year	•	•		•		•	-	
K Steering stem bearing-lubricate	2 years				•			-	
K Master cylinder cup and dust seal-replace	2 years							-	
K Caliper piston seal and dust seal-replace	2 years							-	
K Brake hose-replace	4 years							-	
K Fuel hose-replace	4 years							-	
Drive chain-lubricate	Every 300 km (200 mi)							70	
Drive chain slack-check †	Every 800 km (500 mi)							66	

K : Should be serviced by an authorized Kawasaki dealer.

***** : For higher odometer readings, repeat at the frequency interval established here.

† : Replace, add, adjust, or torque if necessary.

Engine Oil

In order for the engine, transmission, and clutch to function properly, maintain the engine oil at the proper level, and change the oil and oil filter in accordance with the Periodic Maintenance Chart. Not only do dirt and metal particles collect in the oil, but the oil itself loses its lubricative quality if used too long.

▲WARNING

Motorcycle operation with insufficient, deteriorated, or contaminated engine oil will cause accelerated wear and may result in engine or transmission seizure, accident, and injury.

Oil Level Inspection

- Situate the motorcycle so that it is perpendicular to the ground.
- If the oil has just been changed, start the engine and run it for several minutes at idle speed. This fills the oil fil-

ter with oil. Stop the engine and leave it for one minute.

CAUTION

Racing the engine before the oil reaches every part can cause engine seizure.

- If the motorcycle has just been used, run the engine for about 20 seconds at idle speed. Stop the engine and leave it one minute.
- Check the engine oil level through the oil level gauge in the lower right side of the engine. The oil level should come up between the upper and lower level.

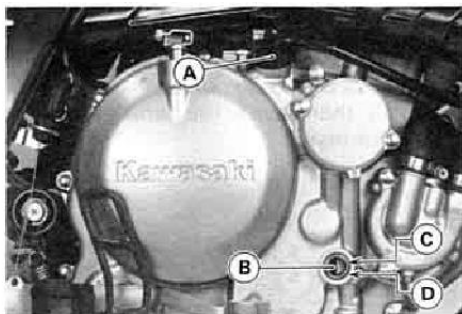

A. Oil Filler Cap C. Upper Level
B. Oil Level Gauge D. Lower Level

- If the oil level is too high, remove the excess oil, using a syringe or some other suitable device.
- If the oil level is too low, add the correct amount of oil through the oil filler opening. Use the same type and brand of oil that is already in the engine.

Oil and/or Oil Filter Change

- Warm up the engine thoroughly, and then stop the engine.
- Set the motorcycle up on its side stand.
- Place an oil pan beneath the engine.
- Remove the engine drain plug and magneto flywheel cover drain plug.

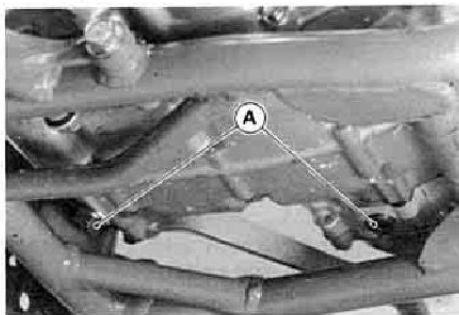

A. Drain Plugs

- With the motorcycle perpendicular to the ground, let the oil completely drain.

- If the oil filter is to be changed, remove the oil filter cover bolts and take off the cover with O-ring.

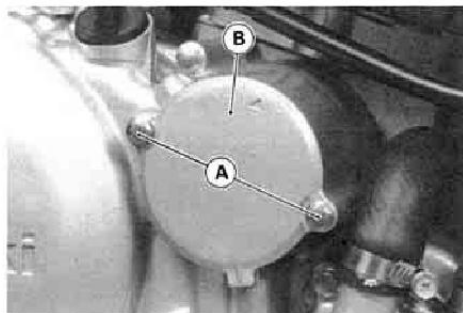

A. Bolts

B. Oil Filter Cover

- Pull off the element with the element mounting pin and collar.
- Remove the collar and pull the mounting pin off the element.
- Replace the element with a new one.
- Apply a little engine oil to the grommets on both side of the element, and push the mounting pin into the ele-

ment. Be careful that the grommets do not slip out of place.

- Fit the collar in the element mounting pin hole of the crankcase.
- Install them with the smaller end of the pin inside.

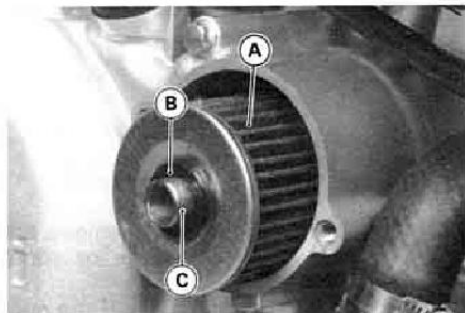

A. Element

C. Mounting Pin

B. Grommet

- Install the oil filter cover and tighten its bolts.
- After the oil has completely drained out, install the engine and magneto

flywheel cover drain plugs with its gasket. Proper torque for it is shown in the table.

NOTE

- *Replace the damaged gasket with a new one.*
- Fill the engine up to the upper level with a good quality motor oil specified in the table.
- Check the oil level.

Tightening Torque

Engine Drain Plug: 29 N-m (3.0 kg-m, 22 ft-lb)
Magneto Flywheel Cover Drain Plug: 24 N-m (2.5 kg-m, 18 ft-lb)

Engine Oil

Grade:	SE, SF or SG class
Viscosity:	SAE 10W40, 10W50, 20W40, or 20W50
Capacity:	1.9 L (2.0 US qt) [when filter is not removed] 1.9 L (2.0 US qt) [when filter is removed] 2.1 L (2.2 US qt) [when engine is completely dry]

Cooling System

Radiator and Cooling Fan:

Check the radiator fins for obstruction by insects or mud. Clean off any obstructions with a stream of low-pressure water.

▲WARNING

The cooling fan turns on automatically, even with the ignition switch off. Keep your hands and clothing away from the fan blades at all times.

CAUTION

Using high-pressure water, as from car wash facility, could damage the radiator fins and impair the radiator's effectiveness.

Do not obstruct or deflect airflow through the radiator by installing unauthorized accessories in front of the radiator or behind the cooling fan.

Interference with the radiator airflow can lead to overheating and consequent engine damage.

Radiator Hoses:

Check the radiator hoses for cracks or deterioration, and connections for looseness in accordance with the periodic Maintenance Chart.

Coolant:

Coolant absorbs excessive heat from the engine and transfers it to the air at the radiator. If the coolant level becomes low, the engine overheats and may suffer severe damage. Check the coolant level each day before riding the motorcycle, and replenish coolant if the level is low. Change the coolant in accordance with the Periodic Maintenance Chart.

NOTE

○ A permanent type of antifreeze is installed in the cooling system when shipped. It is colored green and contains ethylene glycol. It is mixed at 50% and has the freezing point of -35°C (-31°F).

Coolant Level Inspection

● Check the coolant level with the motorcycle held level. The coolant level should be between the FULL and LOW marks.

NOTE

○ Check the level when the engine is cold (room or atmospheric temperature).

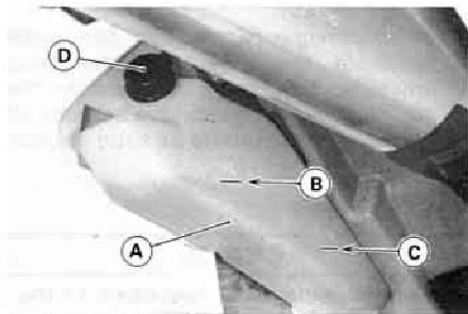

- A. Reserve Tank
- B. FULL Mark
- C. LOW Mark
- D. Tank Cap

- If the amount of coolant is insufficient, unscrew the cap from the reserve tank, and add coolant through the filler opening to the FULL mark. Install the cap.

NOTE

- *In an emergency you can add water alone to the coolant reserve tank, however it must be returned to the correct mixture ratio by the addition of antifreeze concentrate as soon as possible.*

CAUTION
<p>If coolant must be added often, or the reserve tank completely runs dry, there is probably leakage in the system. Have the cooling system inspected by your authorized Kawasaki dealer.</p>

Coolant Change

Have the coolant changed by an authorized Kawasaki dealer.

Spark Plug

The standard spark plug is shown in the table. The spark plug should be taken out periodically in accordance with the Periodic Maintenance Chart for cleaning, inspection, and resetting of the plug gap.

Maintenance

If the plug is oily or has carbon built up on it, have it cleaned, preferably in a sand-blasting device, and then clean off any abrasive particles. The plug may also be cleaned using a high flash-point solvent and a wire brush or other suitable tool. Measure the gap with a wire-type thickness gauge, and adjust the gap if incorrect by bending the outer electrode. If the spark plug electrodes are corroded or damaged, or if the insulator is cracked, replace the plug. Use the standard plug.

Spark Plug Removal

- Remove the left and right radiator covers.
- Remove the seat.
- Turn the fuel tap to the OFF position.
- Pull the carburetor fuel hose off the fuel tap.
- Remove the fuel tap mounting bolts.

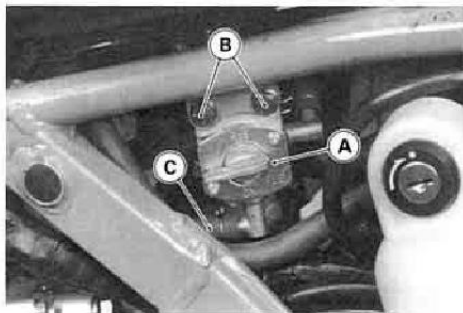

A. Fuel Tap

B. Mounting Bolts

C. Fuel Hose

- Remove the fuel tank mounting bolts and remove the fuel tank.

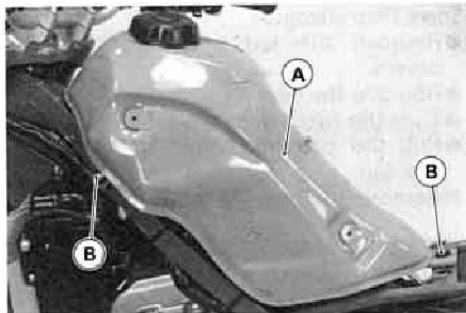

A. Fuel Tank

B. Mounting Bolt

- Carefully pull the spark plug cap from the spark plug.
- Unscrew the spark plug.

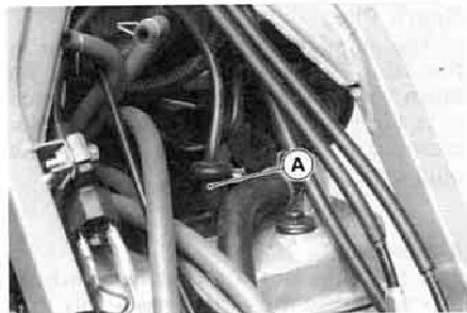

A. Spark Plug Cap

NOTE

- *Spark plug installation is performed in the reverse order of removal.*

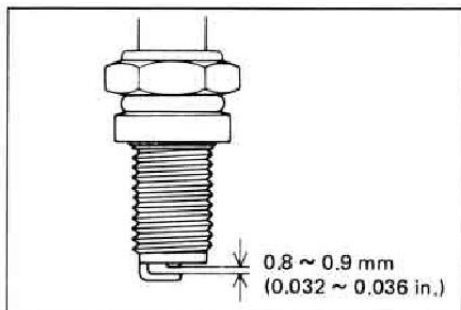

Spark Plug

Standard Plug	NGK DPR8EA-9 or ND X24EPR-U9
Plug Gap	0.8 ~ 0.9 mm (0.032 ~ 0.036 in.)
Tightening Torque	14 N-m (1.4 kg-m, 10.0 ft-lb)

Valve Clearance

Valve and valve seat wear decreases valve clearance, upsetting valve timing.

CAUTION

If valve clearance is left unadjusted, the wear will eventually cause the valves to remain partly open; which lowers performance, burns the valves and valve seats, and may cause serious engine damage.

Valve clearance for each valve should be checked and adjusted in accordance with the Periodic Maintenance Chart.

Inspection and adjustment should be done by an authorized Kawasaki dealer.

Air Cleaner

A clogged air cleaner restricts the engine's air intake, increasing fuel consumption, reducing engine power, and causing spark plug fouling.

The air cleaner element must be cleaned and replaced in accordance with the Periodic Maintenance Chart. In dusty areas, the element should be cleaned more frequently than the recommended interval. After riding through rain or on muddy roads, the element should be cleaned immediately. The element should be replaced if it is damaged.

Element Removal

- Remove the seat.
- Unscrew the air cleaner intake cap screw and remove the air cleaner intake cap.

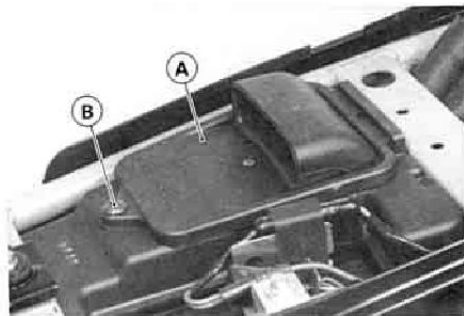

A. Air Cleaner Intake Cap

B. Screw

- Remove the wing bolt, and take out the element.

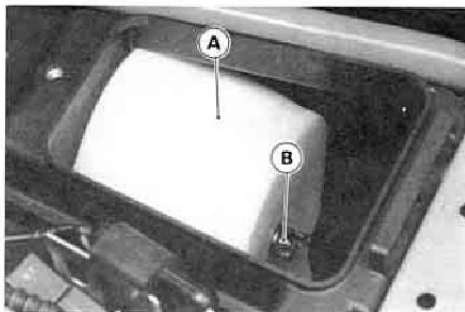

A. Element

B. Wing Bolt

- Remove the element from the frame.

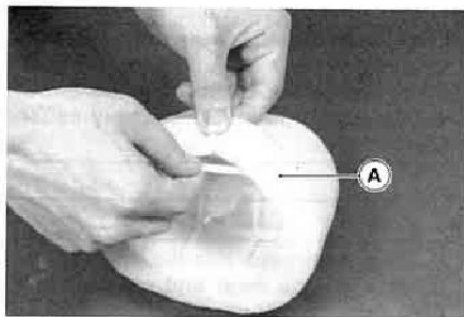

A. Element

- Put a clean, lint-free towel over the air cleaner housing to keep dirt or other foreign material from entering.
- Inspect the element material for damage. If any part of the element is damaged, the element must be replaced.

⚠ WARNING

If dirt or dust is allowed to pass through into the carburetor, the throttle may become stuck, possibly causing accident.

CAUTION

If dirt gets through into the engine, excessive engine wear and possibly engine damage will occur.

NOTE

- *Element installation is performed in the reverse order of removal.*
- *When installing the element, coat the lip of the element with a thick layer of all purpose grease to assure a complete seal against the air cleaner element base. Also, coat the base where the lip of the element fits.*

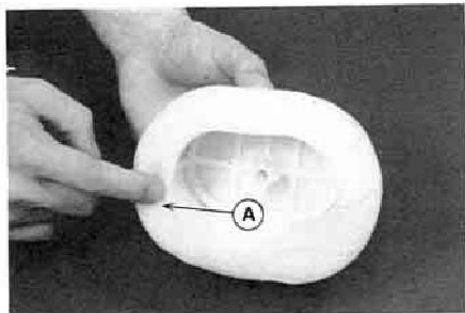

A. Grease

Element Cleaning

- Clean the element in a bath of a high flash-point solvent.
- Dry the element with compressed air or by squeeze it.
- After cleaning, saturate the element with 2-stroke racing oil or high-quality foam-air-filter oil, squeeze out the excess oil, then wrap it in a clean rag and squeeze it as dry

as possible. Be careful not to tear the element.

⚠ WARNING

Clean the element in a well ventilated area, and take care that there are no sparks or flame anywhere near the working area; this includes any appliance with a pilot light. Do not use gasoline or a low flash-point solvent to clean the element. A fire or explosion could result.

Oil Draining

- Inspect the transparent reservoir below the air cleaner housing to see if any oil has run down from the air cleaner housing.

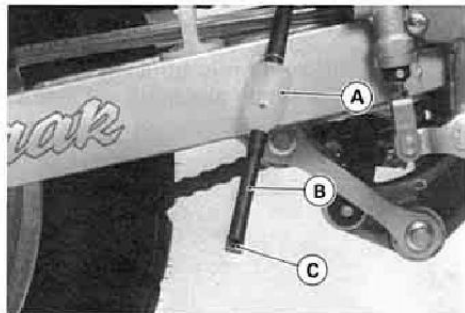

A. Reservoir
B. Drain Hose

C. Plug

- If there is any oil in the reservoir, remove the plug from the lower end of the drain hose and drain the oil.

⚠ WARNING

Be sure to install the plug in the drain hose after draining. Oil on tires will make them slippery and can cause an accident and injury.

Dust and/or Water Inspection

- Push open the drain hose on the bottom of the air cleaner housing to expel dust and/or water accumulated inside.

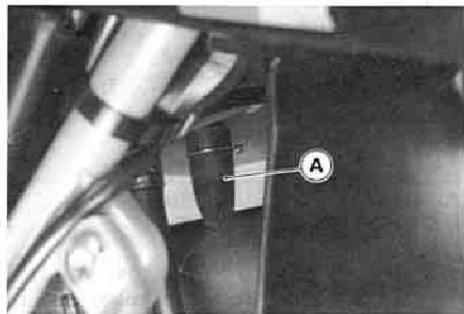

A. Drain Hose

Throttle Grip

The throttle grip controls the throttle valves. If the throttle grip has excessive play due to either cable stretch or maladjustment, it will cause a delay in throttle response, especially at low engine speed. Also, the throttle valves may not open fully at full throttle. On the other hand, if the throttle grip has no play, the throttle will be hard to control, and the idle speed will be erratic. Check the throttle grip play periodically in accordance with the Periodic Maintenance Chart, and adjust the play if necessary.

Inspection

- Check that there is 2 ~ 3 mm (0.08 ~ 0.12 in.) throttle grip play when lightly turning the throttle grip back and forth.
- If there is improper play, adjust it.

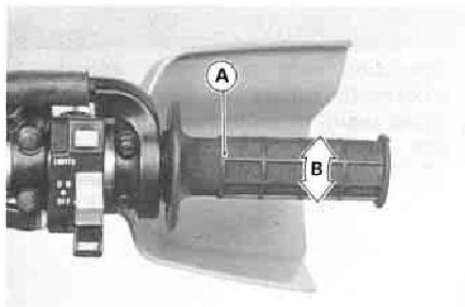

A. Throttle Grip
B. 2 ~ 3 mm (0.08 ~ 0.12 in.)

Adjustment

- Loosen the locknut at the throttle grip, and turn the adjuster until the proper amount of throttle grip play is obtained.

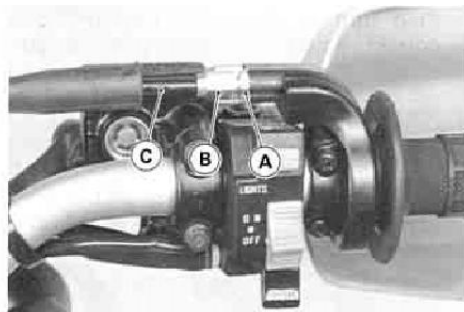

A. Locknut **C. Throttle Cable**
B. Adjuster **(Accelerator Cable)**

- Tighten the locknut.
- If the throttle cable can not be adjusted by using the cable adjuster at the upper end of the throttle cable, use the nuts on the accelerator cable at the carburetor.
- Loosen the locknut at the throttle grip and turn in the adjuster fully.
- Tighten the locknut.
- Loosen the upper nut and turn out the lower nut on the accelerator cable,

then turn in the upper nut until the correct amount of free play is obtained.

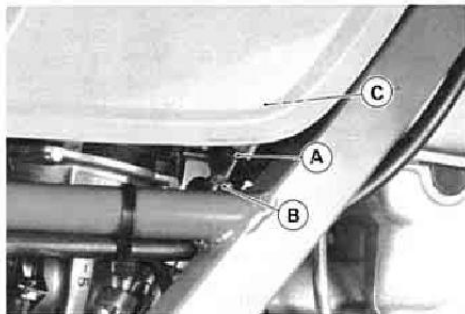

- A. Upper Nut
- B. Lower Nut
- C. Accelerator Cable

- If there is excess play, use the adjuster at the throttle grip.

▲ WARNING

Operation with improperly adjusted, incorrectly routed, or damaged cable could result in an unsafe riding condition.

Carburetor

The following procedure covers the idle speed adjustment, which should be performed in accordance with the Periodic Maintenance Chart or whenever the idle speed is disturbed.

Adjustment

- Start the engine, and warm it up thoroughly.
- Adjust the idle speed to 1,200 ~ 1,400 r/min (rpm) by turning the idle adjusting screw.
- Open and close the throttle a few times to make sure that the idle speed does not change. Readjust if necessary.
- With the engine idling, turn the handlebar to each side. If handlebar movement changes the idle speed, the throttle cables may be improperly adjusted or incorrectly routed, or they may be damaged. Be sure to correct any of these conditions before riding.



A. Idle Adjusting Screw

▲WARNING

Operation with damaged cables could result in an unsafe riding condition.

Clutch

Due to friction plate wear and clutch cable stretch over a long period of use, the clutch must be adjusted in accordance with the Periodic Maintenance Chart.

⚠ WARNING

To avoid a serious burn, never touch a hot engine or exhaust pipe during clutch adjustment.

Inspection

- Check that the clutch lever has 10 ~ 20 mm (0.4 ~ 0.8 in.) of play as shown in the figure.

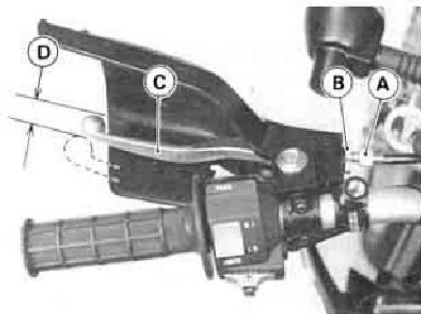

A. Adjuster

B. Locknut

C. Clutch Lever

D. 10 ~ 20 mm
(0.4 ~ 0.8 in.)

If it does not, adjust the lever play as follows.

Adjustment

- Slide the dust cover at the clutch lever out of place.
- Loosen the locknut at the clutch lever.
- Turn the adjuster so that the clutch lever will have 10 ~ 20 mm (0.4 ~ 0.8 in.) of play.

⚠WARNING

Be sure the upper end of the clutch outer cable is fully seated in its fitting, or it could slip into place later, creating enough cable play to prevent clutch disengagement, resulting in a hazardous riding condition.

- Tighten the locknut.
- If it cannot be done, use the mounting nuts at the lower end of the cable.

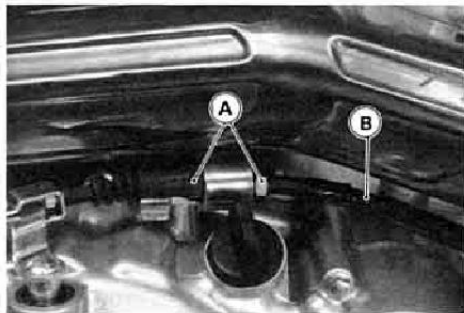

A. Mounting Nuts

B. Clutch Cable

NOTE

- *After the adjustment is made, start the engine and check that the clutch does not slip and that it releases properly.*

Drive Chain

The drive chain must be checked, adjusted, and lubricated in accordance with the Periodic Maintenance Chart for safety and to prevent excessive wear. If the chain becomes badly worn or maladjusted – either too loose or too tight – the chain could jump off the sprockets or break.

⚠ WARNING

A chain that breaks or jumps off the sprockets could snag on the engine sprocket or lock the rear wheel, severely damaging the motorcycle and causing it to go out of control.

Chain Slack Inspection

- Set the motorcycle up on its side stand.
- Rotate the rear wheel to find the position where the chain is tightest.
- Measure space between the chain and the swing arm upper surface at the rear

of the chain sliper should be 55 ~ 65 mm (2.2 ~ 2.6 in.).



A. 55 ~ 65 mm (2.2 ~ 2.6 in.)

- If the drive chain is too tight or too loose, adjust it so that the chain slack will be within the standard value.

Drive Chain Slack

Standard	55 ~ 60 mm (2.2 ~ 2.4 in.)
Too tight	less than 55 mm (2.2 in.)
Too loose	more than 65 mm (2.6 in.)

Chain Slack Adjustment

- Loosen the left and right chain adjuster locknuts.
- Remove the cotter pin, and loosen the rear axle nut.

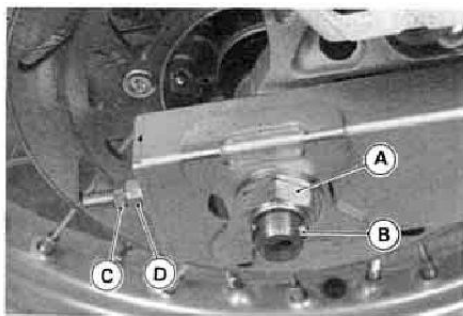

A. Axle Nut
B. Cotter Pin

C. Locknut
D. Adjusting Nut

- If the chain is too tight, back out the left and right chain adjusting nuts evenly, and kick the wheel forward until the chain is too loose.
- Turn in both chain adjusting nuts evenly until the drive chain has the correct amount of slack. To keep the chain and wheel properly aligned, the notch on the left chain adjuster should align with the same swing arm mark

that the right chain adjuster notch aligns with.

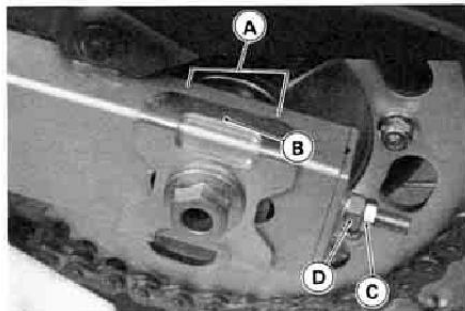

A. Marks
B. Notch

C. Locknut
D. Adjusting Nut

NOTE

- *Wheel alignment can also be checked using the straightedge or string method.*

⚠ WARNING

Misalignment of the wheel will result in abnormal wear, and may result in an unsafe riding condition.

- Tighten both chain adjuster locknuts.
- Tighten the axle nut to the specified torque.

Tightening Torque

Axle Nut:	98 N-m (10.0 kg-m, 72 ft-lb)
-----------	---------------------------------

- Rotate the wheel, measure the chain slack again at the tightest position, and readjust if necessary.
- Insert a new cotter pin through the axle, and spread its ends.

⚠WARNING

If the axle nut is not securely tightened, or the cotter pin is not installed, an unsafe riding condition may result.

Wear Inspection

- Stretch the chain taut either by using the chain adjusters, or by hanging a 10 kg (20 lb) weight on the chain.
- Measure the length of 20 links on the straight part of the chain from pin center of the 1st pin to pin center of the 21st pin. Since the chain may wear unevenly, take measurements at several places.
- If the length exceeds the service limit, the chain should be replaced.

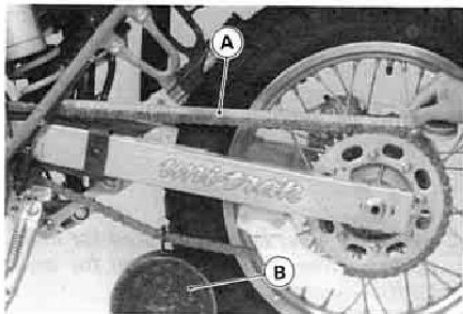

A. Measure

B. Weight

Drive Chain 20-Link Length

Service Limit: 323 mm (12.7 in.)

⚠WARNING

For safety, use only the standard chain. It is an endless type and should not be cut for installation; have it installed by an authorized Kawasaki dealer.

- Rotate the rear wheel to inspect the drive chain for damaged rollers, and loose pins and links.
- Also inspect the sprockets for unevenly or excessively worn teeth, and damaged teeth.

NOTE

- *Sprocket wear is exaggerated for illustration. See Service Manual for wear limits.*

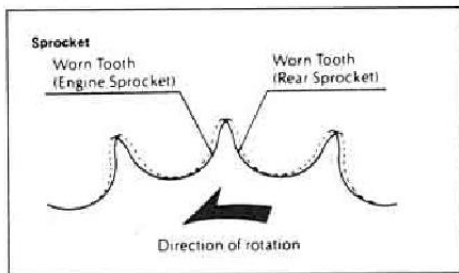

- If there is any irregularity, have the drive chain and/or the sprockets re-

placed by an authorized Kawasaki dealer.

Lubrication

Lubrication is also necessary after riding through rain or on wet roads, or any time that the chain appears dry. A heavy oil such as SAE 90 is preferred to a lighter oil because it will stay on the chain longer and provide better lubrication.

- Apply oil to the sides of the rollers so that it will penetrate to the rollers and bushings. Apply oil to the O-rings so that the O-rings will be coated with oil. Wipe off any excess oil.

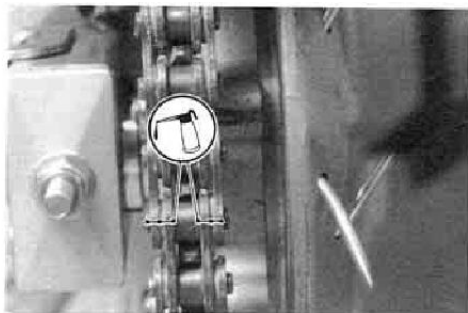

- If the chain is especially dirty, clean it using diesel oil or kerosine and then apply oil as mentioned above.

Brakes

Disc and disc pad wear is automatically compensated for and has no effect on the brake lever or pedal action. So there are no parts that require adjustment on the brakes except brake lever play.

Front Brake Lever Play

The brake lever has 2 ~ 5 mm (0.08 ~ 0.20 in) of play when the brake is lightly applied.

To adjust the brake lever play, loosen the locknut and turn the adjuster to either side. After adjustment, tighten the locknut securely and check the braking effectiveness.

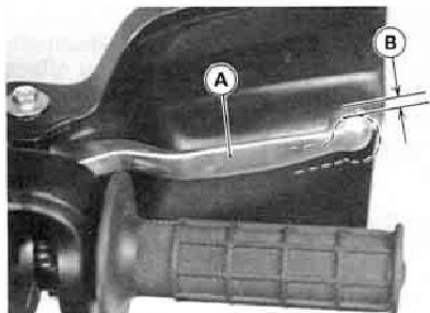

A. Brake Lever
B. 2 ~ 5mm (0.08 ~ 0.20 in)

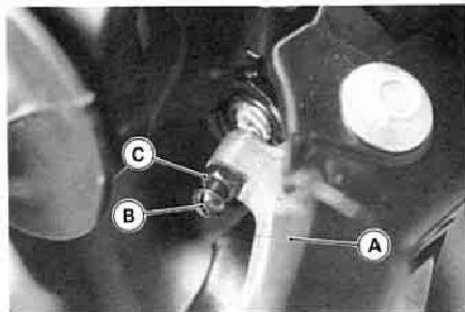

A. Brake Lever **C. Locknut**
B. Adjuster

⚠ WARNING

If the brake lever or pedal feels mushy when it is applied, there might be air in the brake lines or the brake may be defective. Since it is dangerous to operate the motorcycle under such conditions, have the brake checked immediately.

Brake Wear Inspection

In accordance with the Periodic Maintenance Chart, inspect the brakes for wear. For each front and rear disc brake caliper, if the thickness of either pad is less than 1 mm (0.04 in), replace both pads in the caliper as a set. Pad replacement should be done by an authorized Kawasaki dealer.

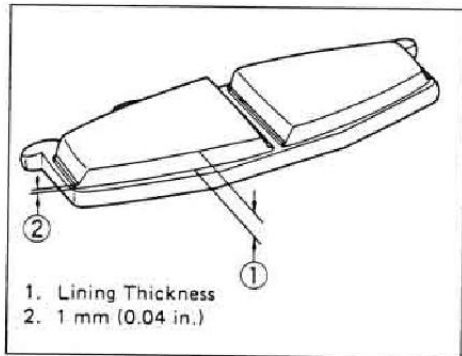

Disc Brake Fluid:

In accordance with the Periodic Maintenance Chart, inspect the brake fluid level in the reservoirs and change the brake fluid. The brake fluid should also be changed if it becomes contaminated with dirt or water.

Fluid Requirement

Recommended fluids are given in the table. If none of the recommended brake fluids are available, use extra heavy-duty brake fluid only from a container marked D.O.T.3 or D.O.T.4.

Recommended Disc Brake Fluid

(D.O.T.3)

Atlas Extra Heavy Duty
Shell Super Heavy Duty
Texaco Super Heavy Duty
Wagner Lockheed Heavy Duty
Castrol Girling-Universal
Castrol GT (LMA)
Castrol Disc Brake Fluid

(D.O.T.4)

Castrol Girling-Universal
Castrol GT (LMA)
Castrol Disc Brake Fluid
Check Shock Premium Heavy Duty

NOTE

○ *Brake fluid of D.O.T.4 is installed in the brake system when shipped.*

CAUTION

Do not spill brake fluid onto any painted surface.

Do not use fluid from a container that has been left open or that has been unsealed for a long time.

Check for fluid leakage around the fittings.

Check for brake hose damage.

Fluid Level Inspection

- The brake fluid level in the front brake fluid reservoir must be kept above the line (lower level line) next to the gauge and that in the rear reservoir must be kept between the upper and lower level lines (reservoirs held horizontal).

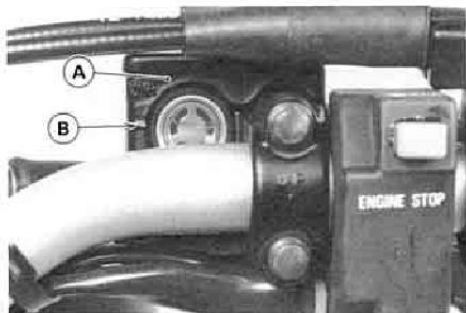

A. Front Reservoir
B. Lower Level Line

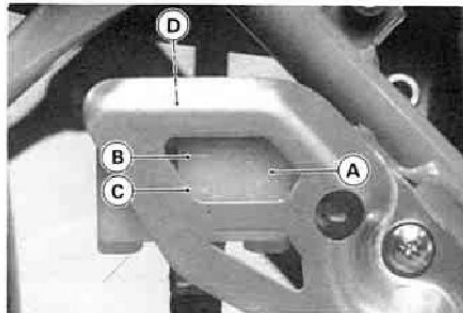

A. Rear Reservoir
B. Upper Level Line
C. Lower Level Line
D. Filler Cap

- If the fluid level in each reservoir is lower than the lower level line, check for fluid leaks in the brake lines, and fill the reservoir to the upper level line. Inside the front reservoir is a upper end of the stepped portion showing the upper level line.

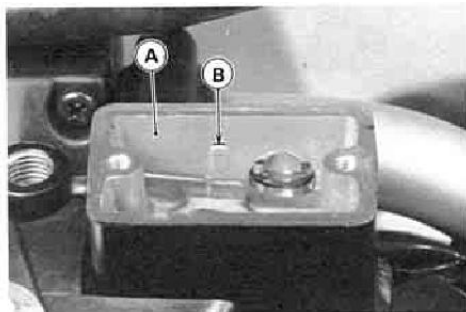

- A. Front Reservoir
- B. Upper Level Line

Fluid Change

Have the brake fluid changed by an authorized Kawasaki dealer.

▲WARNING

Do not mix two brands of fluid. Change the brake fluid in the brake line completely if the brake fluid must be refilled but the type and brand of the brake fluid that is already in the reservoir are unidentified.

Brake Light Switches

When either the front or rear brake is applied, the brake light goes on. The front brake light switch requires no adjustment, but the rear brake light switch should be adjusted in accordance with the Periodic Maintenance Chart.

Inspection

- Turn on the ignition switch.
- The brake light should go on when the front brake is applied.
- If it does not, ask your authorized Kawasaki dealer to inspect the front brake light switch.
- Check the operation of the rear brake light switch by depressing the brake pedal. The brake light should go on after about 10 mm (0.4 in.) of pedal travel.

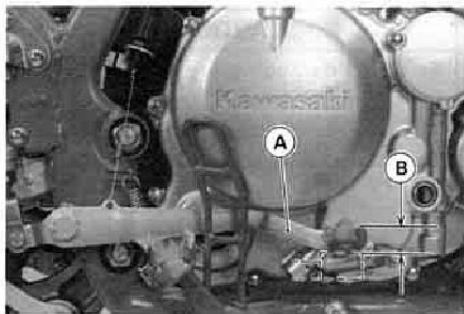

A. Brake Pedal

B. 10 mm (0.4 in.)

- If it does not, adjust the rear brake light switch.

Adjustment

- To adjust the rear brake light switch, move the switch up or down by turning the adjusting nut.

CAUTION

To avoid damaging the electrical connections inside the switch, be sure that the switch body does not turn during adjustment.

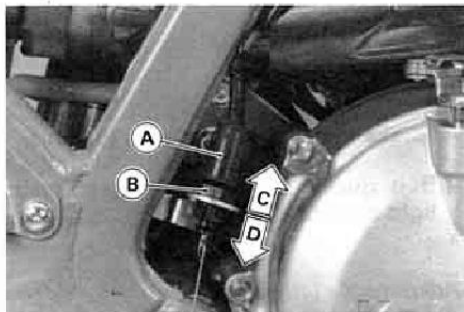

- A. Rear Brake Light Switch
- B. Adjusting Nut
- C. Lights sooner.
- D. Lights later.

Front Fork Air Pressure

The standard air pressure in the front fork legs is atmospheric pressure. The air pressure in the fork legs increases as the fork heats up, so the fork action will get stiffer as the vehicle operation progresses.

- Using the jack under the frame, stabilize the motorcycle.
- Place a stand or block under the engine so that the front wheel is raised off the ground.
- Remove the screws at the top of the front fork top bolts.

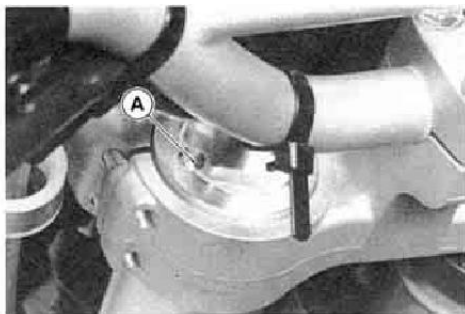

A. Screw

Rear Shock Absorber

The rear shock absorber can be adjusted by changing the spring preload for various riding and loading conditions. If the spring action feels too soft or too stiff, have it adjusted by an authorized Kawasaki dealer.

Wheels

Tires:

Payload and Tire Pressure

Failure to maintain proper inflation pressures or observe payload limits for your tires may adversely affect handling and performance of your motorcycle and can result in loss of control. The maximum recommended load in addition to vehicle weight is 185 kg (408 lb) [Australian model – 190 kg (419 lb)], including rider, passenger, baggage, and accessories.

- Check the tire pressure often, using an accurate gauge.

NOTE

- *Measure the tire pressure when the tires are cold (that is, when the motorcycle has not been ridden more than a mile during the past 3 hours).*
- *Tire pressure is affected by changes in ambient temperature and altitude, and so the tire pressure should be checked and adjusted when your riding in-*

volves wide variations in temperature or altitude.

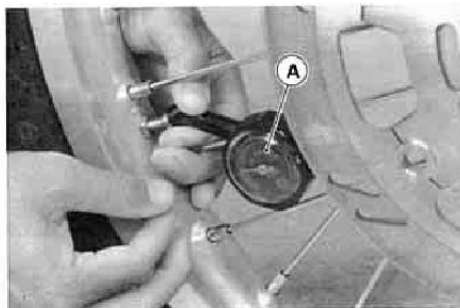

A. Tire Pressure Gauge

Tire Air Pressure (when cold)

Front	150 kPa (1.5 kg/cm ² , 21 psi)	
Rear	Up to 97.5 kg (215 lb) load	150 kPa (1.5 kg/cm ² , 21 psi)
	97.5 ~ 185 kg (215 ~ 408 lb) [(A) 97.5 ~ 190 kg (215 ~ 419 lb)] load	200 kPa (2.0 kg/cm ² , 28 psi)

(A): Australian model

Tire Wear, Damage

As the tire tread wears down, the tire becomes more susceptible to puncture and failure. An accepted estimate is that 90% of all tire failures occur during the last 10% of tread life (90% worn). So it is false economy and unsafe to use the tires until they are bald.

- In accordance with the Periodic Maintenance Chart, measure the depth of the tread with a depth gauge, and re-

place any tire that has worn down to the minimum allowable tread depth.

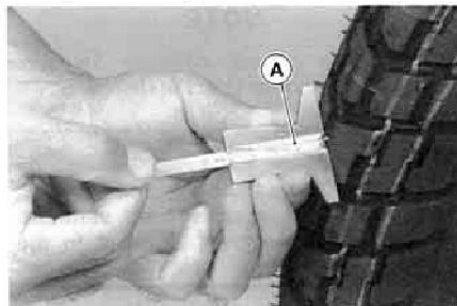

A. Tire Depth Gauge

Minimum Tread Depth

Front and Rear	2 mm (0.08 in)
----------------	----------------

- Visually inspect the tire for cracks and cuts, replacing the tire in case of bad damage. Swelling or high spots indicate internal damage, requiring tire replacement.

- Remove any imbedded stones or other foreign particles from the tread.

NOTE

- *Have the wheel balance inspected whenever a new tire is installed.*

▲WARNING

To ensure safe handling and stability, use only the recommended standard tires for replacement, inflated to the standard pressure.

Standard Tire (~~Tubeless~~)

Front	○ 90/90-21 54S DUNLOP TRAILMAX
Rear	○ 130/80-17 65S DUNLOP TRAILMAX

Battery

The battery installed in this motorcycle is a maintenance-free type, so it is not necessary to check the battery electrolyte level or add distilled water.

The sealed cap should not be pulled off once the specified electrolyte has been installed in the battery for initial service.

Since the electrical system of this motorcycle is designed to use only a maintenance-free battery, do not replace it with a conventional battery.

CAUTION

**Never remove the sealed cap, or the battery can be damaged.
Do not install a conventional battery in this motorcycle, or the electrical system will not work properly.**

NOTE

- If you charge the maintenance-free battery, never fail to observe the instructions shown in the label on the battery.

Battery Removal

- Remove the left side cover and battery cover.
- Remove the battery band.
- Unscrew the fuse case holder screw and take the holder out above the battery.
- Disconnect the leads from the battery, first from the (-) terminal and then the (+) terminal.

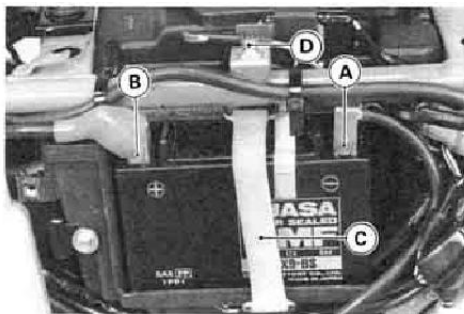

- A. (-) Terminal
- B. (+) Terminal
- C. Battery Band
- D. Screw

- Take the battery out of the case.
- Clean the battery using a solution of baking soda and water. Be sure that the lead connections are clean.

Battery Installation

- Connect the capped lead to the (+) terminal, and then connect the black lead to the (-) terminal.

- Cover the (+) terminal with its protective cap.
- Reinstall the removed parts.

Headlight Beam

Horizontal Adjustment

The headlight beam is adjustable horizontally. If not properly adjusted horizontally, the beam will point to one side rather than straight ahead.

- Turn the adjusting screw on the headlight rim in or out until the beam points straight ahead. Turning the adjusting screw clockwise makes the headlight beam point to the right.

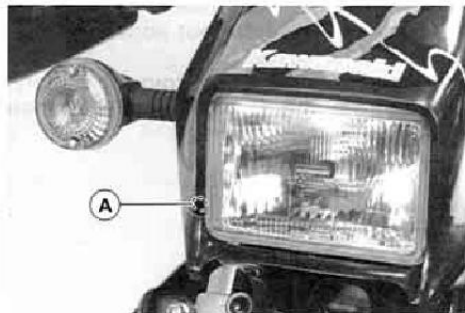

A. Adjusting Screw

Vertical Adjustment

The headlight beam is adjustable vertically. If adjusted too low, neither low nor high beam will illuminate the road far enough ahead. If adjusted too high, the high beam will fail to illuminate the road close ahead, and the low beam will blind oncoming drivers.

- Remove the mounting screws, and take off the headlight cover.

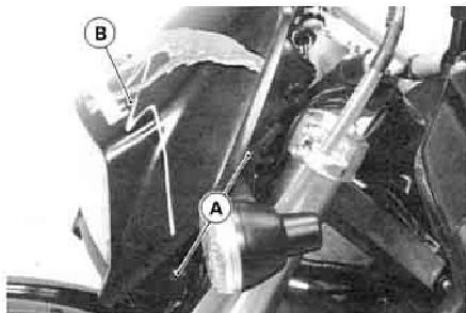

A. Mounting Screws
B. Headlight Cover

- Loosen the lower headlight bolt, and adjust the headlight vertically.



A. Lower Headlight Bolt

- Tighten the lower headlight bolt.
- Install the headlight cover, and tighten the mounting screws securely.

NOTE

- *On high beam, the brightest point should be slightly below horizontal with the motorcycle on its wheels and the rider seated. Adjust the headlight to the proper angle according to local regulations.*

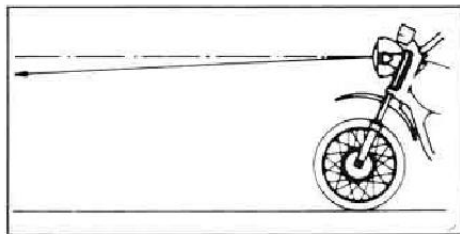

CAUTION

When handling the quartz-halogen bulbs, never touch the glass portion with bare hands. Always use a clean cloth. Oil contamination from hands or dirty rags can reduce bulb life or cause the bulb to explode.

Fuses

The fuse case is located under the seat. The main fuse is mounted on the starter relay behind the starter motor. If a fuse fails during operation, inspect the electrical system to determine the cause, and then replace it with a new fuse of proper amperage.

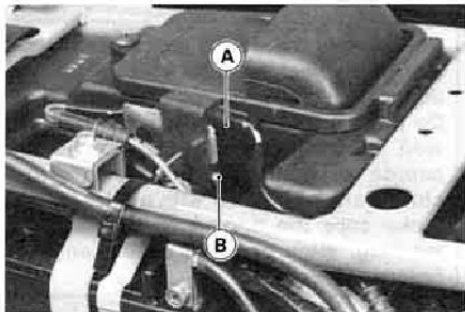

A. Fuse Case

B. Spare Fuse

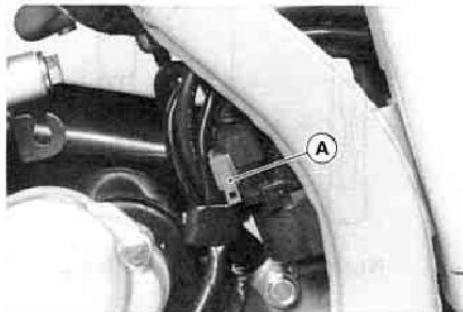

A. Main Fuse

⚠ WARNING

Do not use any substitute for the standard fuse.

Replace the blown fuse with a new one of the correct capacity, as specified on the junction box.

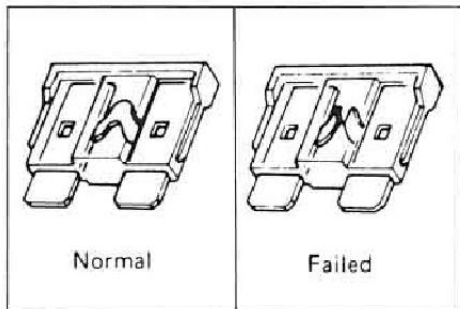
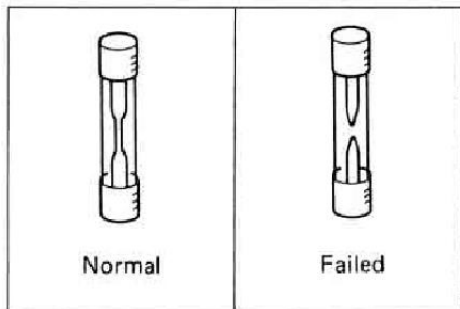

Fuel System

Accumulation of moisture or sediment in the fuel system will restrict the flow of fuel and cause carburetor malfunction. The system should be checked and cleaned in accordance with the Periodic Maintenance Chart.

⚠ WARNING

Gasoline is extremely flammable and can be explosive under certain conditions. Turn the ignition switch OFF. Do not smoke. Make sure the area is well ventilated and free from any source of flame or sparks; this includes any appliance with a pilot light. Make sure the engine is cold before working. Wipe any fuel off the engine before starting it.

Inspection

- Run the lower end of the drain hose into a suitable container.

- Turn out the drain screw a few turns to drain the carburetor, and check to see if water or dirt has accumulated in the carburetor.

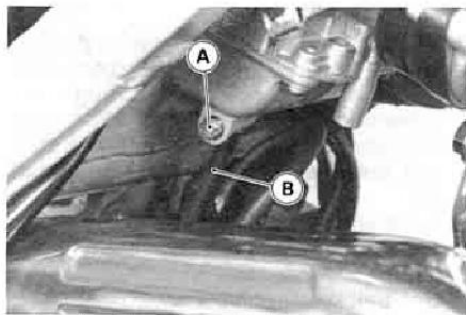

A. Drain Screw B. Drain Hose

- Tighten the drain screw.

NOTE

- If any water or dirt appears during the above operation, have the fuel system checked by an authorized Kawasaki dealer.

Cleaning

For the prolonged life of your motorcycle, wash it down immediately after it has been splashed with seawater or exposed to the sea breeze; operated on rainy days, rough roads, or in dusty areas; or operated on roads on which salt has been scattered for ice removal.

Preparation for Washing

Before washing, precautions must be taken to keep water off the following places:

- Rear opening of muffler; Cover with the plastic bag secured with the rubber band.
- Clutch and brake levers, switch housings on the handlebar; Cover with plastic bags.
- Ignition switch; Cover the keyhole with tape.
- Air cleaner intake; Close up the intake with tape, or stuff with rags.

Where to be Careful

Avoid spraying water with any great force near the following places:

- Meter instruments
- Disc brake master cylinders and calipers
- Under the fuel tank; If water gets into the ignition coil or into the spark plug cap, the spark will jump through the water and be grounded out. When this happens, the motorcycle will not start and the affected parts must be wiped dry.
- Front and rear wheel hubs
- Steering pivot (steering stem head pipe)
- Uni-trak system pivots.
- Swing arm pivot

NOTE

- *Coin operated, high pressure spray washers are not recommended. The water may be forced into bearings and other components causing eventual failure from rust and corrosion. Some*

of the soaps which are highly alkaline leave a residue or cause spotting.

After Washing

- Remove the plastic bags and tape, and clean the air cleaner intake.
- Lubricate the pivots, bolts, and nuts.
- Test the brakes before motorcycle operation.
- Start the engine and run it for 5 minutes.

▲WARNING

Never wax or lubricate the brake discs. Loss of braking and an accident could result. Clean the discs with an oilless solvent such as trichloroethylene or acetone. Observe the solvent manufacturer's warnings.

- Spray oil on all unpainted metal surfaces to prevent rusting. Avoid getting oil on rubber parts or in the brakes.
- Lubricate the drive chain and all the cables.
- Remove the battery, and store it where it will not be exposed to direct sunlight, moisture, or freezing temperatures.
- Tie a plastic bag over the exhaust pipe to prevent moisture from entering.
- Put a cover over the motorcycle to keep dust and dirt from collecting on it.

Preparation after Storage:

- Remove the plastic bag from exhaust pipe.
- Install the battery in the motorcycle and charge the battery if necessary.
- Make sure the spark plug is tight.
- Fill the fuel tank with fuel.
- Check all the points listed in the Daily Safety Checks section.
- Lubricate the pivots, bolts, and nuts.

KLX650-C2



KAWASAKI
HEAVY INDUSTRIES, LTD.
CONSUMER PRODUCTS GROUP

Part No. 99922-1704-02

Printed in Japan